

User Manual

Galaxis Showtechnik

PYROTEC

G-Flame



Firmware V2.41
Revision date: April 14th 2020

Batch No.: EUF100101, USF100101

Table of contents:

1	Introduction	5
1.1	Safety instructions	5
1.2	Requirements the operator has to fulfill and necessary qualification.....	6
1.3	General safety instructions when using the G-Flame	7
1.4	Application fields and intended use.....	12
1.5	Required approvals	12
2	Illustration and description of indicators and control elements	13
2.1	Main unit	13
2.2	Carrying handle	15
2.3	Cover panel	16
2.4	Cartridge holder.....	16
3	Nozzles for different types of fuel.....	17
3.1	Changing the nozzles and nozzle holder	18
3.2	Sealing of the nozzles or respectively of the nozzle thread	18
4	The various inputs and their compatibility and usage, pin assignments of connectors.....	19
4.1	The emergency off input.....	19
4.2	Firing key input	19
4.3	Voltage input 12-24V	20
4.4	Charging	20
4.5	Operation with DMX512	21
4.5.1	The DMX512 input.....	21
4.5.2	Control via DMX512.....	22
4.6	Control of the device via serial data cables via the RS485 interface in conjunction with the PFC Advanced	23
4.7	Advanced wireless module, communication via radio or serial data cables	24
5	Instructions for installation and de-installation of the G-Flame.....	25
5.1	Setup of the G-Flame	25
5.1.1	Operation with aerosol cartridges	26
5.1.2	Operation with gas bottles	26
5.1.3	After opening	26
5.2	De-installation the G-Flame.....	26
5.2.1	Operation with aerosol cartridges	27
5.2.2	Operation with gas bottles	27
5.2.3	After closing	27
5.3	Tilting the G-Flame	28
5.3.1	Instructions for installation at a tilt of 180°	28
5.4	Additional instructions for permanent installations	29
5.4.1	Operation with aerosol cartridges	29
5.4.2	Operation with gas bottles	29
5.5	Instructions regarding the use of Flame Bars	29
5.6	Mounting on light or speaker stands	30
5.7	Mounting on truss elements	30
6	Approved fuels	31
6.1	Approved fuels and instructions if the gas bottle option is being used	31
6.1.1	Instructions regarding the usage of the gasiform phase	31
6.1.2	Instructions regarding the usage of the liquid phase.....	31
6.2	Approved fuels and instructions if the gas cartridge option is being used	33
6.3	Fuel consumption	36
6.3.1	Fuel consumption if gas bottles are being used	36
6.3.2	Fuel consumption if gas cartridges are being used.....	36
7	Safety distances.....	37
7.1	Safety distances if gas bottles are being used, device standing vertically	39
7.2	Safety distances if gas cartridges are being used, device standing vertically	39
7.3	Safety distances when using flame bars.....	40
7.4	Safety distances if the device is being tilted.....	40
7.5	Safety distances if the device is mounted above the spectators	40
7.6	Reduction of the safety distances to actors	40
8	Switching on.....	41
9	Information regarding the firmware version	41



10	Battery monitoring and warning message 'deep discharge' after powering up the device.....	41
10.1	Resetting the warning message 'Battery deeply discharged'.....	42
11	Safety timer	43
12	The warning LED 'Attention armed'	43
13	The LED indicators.....	44
13.1.1	The LED 'Operation' (blue)	44
13.1.2	The LED 'Flame' (yellow).....	44
13.1.3	The LED 'Charging' (green).....	44
13.1.4	The LED 'Low Battery' (red)	44
13.1.5	Functional check of the LEDs.....	44
14	The menu	45
14.1	Standard menu items	45
14.1.1	The menu item 'Language'	45
14.1.2	The menu item 'Accumulator capacity'	45
14.1.3	The menu item 'Accumulator power'	45
14.1.4	The menu item 'Input'	46
14.1.5	The menu item '45° Tilt Switch'	46
14.1.6	The menu item 'Flame monitoring'	47
14.1.7	The menu item 'Acoustic Signals'.....	47
14.1.8	The menu item 'LCD Backlight'	48
14.1.9	The menu item 'Warning LED'	48
14.1.10	The menu item 'Battery measurement'.....	48
14.2	Menu items if DMX512 has been selected as an input.....	50
14.2.1	The menu item 'Flame Channel'	50
14.2.2	The menu item 'Safety Channel'.....	50
14.2.3	The menu item 'Power Supply for Wi-DMX'	51
14.3	Menu items if the Advanced wireless module has been installed and 'Cable (RS485 of PFC)' or 'Wireless (PFC or PFS)' has been selected as control method	52
14.3.1	The menu item 'RF Channel' (i.e. frequency selection).....	52
14.3.2	The menu item 'Interfering Signal'	52
14.3.3	The menu item 'Last Range Test Result'.....	52
14.3.4	The menu item 'Device ID number'	53
14.3.5	The menu item 'Determine Hazard Zone'	53
14.3.6	The menu item 'Terminal Programming'.....	54
14.3.6.1	Overview regarding the parameters of the Terminal	54
14.3.6.2	The selection menu of the Terminal programming.....	55
14.3.6.3	The menu item 'Terminal programming: Keep up & Exit'	55
14.3.6.4	The menu item 'Terminal programming: Edit'	55
14.3.6.5	The menu item 'Terminal programming: Delete'.....	57
15	Receiving mode or respectively ready to fire mode.....	58
15.1	Displayed information during receiving mode or respectively ready to fire mode, that appears in all operation modes	58
15.1.1	Information which control method has been selected	58
15.1.2	Tilt switch on/off and its status.....	58
15.1.3	Flame monitoring on/off.....	59
15.2	Display of special information and behavior of the device in the receiving mode or respectively ready to fire mode if 'Wireless (PFC or PFS)' or 'Cable (RS485 of PFC)' has been selected as control method	59
15.2.1	Status information regarding firing mode and hazard zone	59
15.2.2	Display of the device ID number.....	60
15.2.3	Display of messages.....	60
15.2.4	Programming of the system ID	60
15.2.5	The monitoring function Radio Interference	61
16	Switching off.....	62
17	Command 'Firing mode off'	62
18	Radio range.....	63
18.1	Radio Range Test.....	63
19	Remote access	63
20	Operation time.....	64
21	Installation of accessories.....	65
21.1	Installation of the Advanced wireless module	65
21.1.1	Installation of the hardware	65

21.1.2	Software installation of the Advanced wireless module	65
21.2	De-installation of the wireless module.....	66
21.2.1	De-installation of the wireless module in the software	66
21.2.2	De-installation of the hardware.....	67
21.3	Optional accessory: Power Upgrade.....	67
22	Maintenance and service life	68
23	Cleaning	69
24	Micro filter.....	69
25	Warranty.....	70
26	Damages caused by misuse, maloperation, malfunction	70
27	Technical data.....	71
27.1	General data.....	71
27.2	Usage in rainy conditions	72
28	Accessories.....	73
29	CE marking of the EU version.....	74
30	Address of the manufacturer and contact details for requesting an EU declaration of conformity	74

1 Introduction

1.1 Safety instructions

Observe all safety instructions in this documentation! Safety instructions warn of dangers when handling devices and provide information on how to avoid them. They are classified according to the severity of the danger and divided into the following groups:

<p>DANGER</p> 	<p>Danger signals dangers for persons. If you do not follow the instructions for avoiding the hazard, the hazard will certainly result in death or serious physical injury.</p>
<p>WARNING</p> 	<p>Warning indicates dangers for persons. If you do not follow the instructions for avoiding the hazard, the hazard is likely to result in death or serious injury.</p>
<p>CAUTION</p> 	<p>Caution indicates danger to persons. If you do not follow the instructions for avoiding the hazard, the hazard is likely to result in minor physical injury.</p>
<p>NOTICE</p>	<p>Note signals dangers for objects or data. If you do not follow the instructions for avoiding the hazard, the hazard will probably result in damage to property.</p>
<p>TIP</p>	<p>A tip provides additional or supplementary information.</p>

1.2 Requirements the operator has to fulfill and necessary qualification

This product may only be operated by persons of legal age. In Germany the user must be at least 18 years of age.

This product may only be used within the scope of a professional and occupational activity.

The user must be a qualified person. A qualified person is a trained person who has experience with the technology of the device and is particularly informed about the types of energy used by the device and its size. Electrical and thermal types of energy (fuels) occur in this device.

The specialist is expected to use his training and experience to identify energy sources that can cause pain or injury and to take appropriate measures to protect against pain and injury from these energy sources. In addition, the practitioner must take appropriate measures to ensure that less trained persons cannot be injured. A qualified person can be trained either by the manufacturer of the device or by the customer who purchases the device.

Further qualifications such as stage pyrotechnician, SFX technician or professional fire worker is not required

TIP

Ensure that all legal requirements for operating flame projectors in the country of destination are met.

In Germany, these include the regulations of the employers' liability insurance association, e.g.

- DGUV regulation 215-312: Safety at events and productions
- DGUV regulation 80: Use of liquid gas

1.3 General safety instructions when using the G-Flame

This section is about general safety instructions. You need to mind other safety instructions given in this manual as well. Furthermore, you need to observe the safety distances mentioned in the relevant chapters.

The safety rules enlisted in this manual are referring to the G-Flame only. For the other devices in our product range there is another version of safety instruction which can be found in the user manual of the particular devices.

The following instructions are for your understanding about important and basic safety principles.

Our general safety requirements are based on our own experience plus the contact and feedback from our customers. These rules allow the safe and successful usage of all components of our wireless firing systems. With proceeding development of our products, we will continuously revise and adapt the safety standards in conclusion with your notifications and support.

The following safety instructions are part of all our operation manuals within our product range. These instructions are also available in printed form and can be downloaded via our internet homepage at any time. Please forward these instructions to any relevant persons in your company dealing with this topic.

Any technical device can potentially cause a fault. This could be encouraged through: wrong usage, unit damage, unit aging as well as the wear and tear of the unit. This fundamental thesis was the basic principle when writing these instructions.

The usage of effect devices to generate flame balls and flame columns, especially in indoor and outdoor venues or places of public assembly, can be hazardous and bears many potential risks, such as severe damage to property or personal injury and due to that is of utmost importance to follow all safety instructions whenever the product is being used.

1. Never use the devices if you have not completely read and understood the user manual.
2. Never order somebody to use devices in a potentially risky application if this person is not absolutely reliable or does not have sufficient technical knowledge.
3. The operator who is in charge for the safety has to have complete overview over all devices during the whole application. In addition, he has to be able to take action in the technical control of the system at any time if a potentially dangerous situation is arising. Please refer to the sections in this manual where the 'emergency off' functions are being explained.
4. For the usage of the device in places of public assembly an approval by the authorities that are responsible for the fire prevention is necessary.

5. If flame effects are being used no easily inflammable materials should be present in general. In places of public assembly this kind of material is normally forbidden by the legislator. By the usage of flame retardant spray these materials can be rendered hardly inflammable.

6. Smoking or open fire is strictly prohibited within the safety zone! Keep off any other sources of ignition.

7. Depending on the type, size and quantity of the effects that are being used and depending on the local conditions, allocate the necessary fire prevention and first aid measurements.

8. In all cases respect and follow any national and technical regulations as well as the operation manuals respective to the devices in use.

9. Ensure that the devices are standing securely and that the position or tilt cannot vary during the application. Depending on the circumstances it can be necessary to mount the devices e.g. by using screws. Please mind the chapter in this user manual which is dealing with the mounting of the devices on truss elements.

10. Ensure that the device is not covered by anything and that the fuel can be easily exhausted through the nozzle. Furthermore, ensure that no foreign objects like e.g. confetti or streamers enter the burning chamber.

11. Arm (switch on) the devices as shortly as possible before the effect and disarm (switch off) them immediately after the effect. Optionally this can be achieved either by using the emergency off input or the main switch or the hazard zones or the DMX safety channel. The hazard zones can be turned off and on either by a wireless command or by using serial data cables. As soon as the devices are armed or respectively ready to fire, they must be constantly supervised by the responsible operator.

12. Ensure that no heat sources like strong spotlights are pointed towards the devices or the gas cartridges or the gas bottles.

13. Make sure that non authorized persons cannot gain access to the effect and control devices.

14. The safety boundary distances required by the manufacturer and authorities are to be respected. Secure the area so that non authorized persons cannot gain access to the same.

15. The operation manuals and safety instructions of the manufacturer of the effect and control devices must be observed at all times. If in doubt these must be discussed with the relevant safety organisations.

16. The effect and control devices are only allowed to be used according to the defined applications. Only use fuels that have been approved by the manufacturer.

17. The components of our firing system are to be covered or encased against burn-off cinders or weather conditions where necessary. Electrical contacts should be protected against corrosion, soiling and damage plus they should be cleaned regularly.

18. We recommend to have our products inspected every one to two years. Along with the testing of the rechargeable battery, a visual test as well as a functional test will prove that the operational safety standards are still met.

19. Do not use damaged equipment. If a damage is found, immediately send the device back to the manufacturer for professional repair. Our warranty for the proper function for our equipment is only for components of our system, which have no damage.

20. Any changes in or to the devices as well as repair work on the units other than that through the manufacturer will invalidate any warranty claims and our product liability will be void. Should repair of the units be necessary, then we do require a detailed report of the problem.

21. Please make sure when lending or renting out the equipment, that no damage has occurred during the rental period of the units. Advise your staff, that it is very important to report any possible damage of the units immediately. Customers, which have borrowed or rented the equipment are hereby informed, that it is their duty to report any damage found or suspected on the unit when returning such.

22. When transporting the devices make sure that the packing is sufficient and check the devices after each transport if they have been possibly damaged.

23. Wire connections from the control units to the G-Flame are always to be insulated and must comply with the technical standards. At the same time avoid wire damage, for example through heat, cable twisting, cable pinching and burn-off cinders or through forced piercing. All cables must be checked before each use on its faultless construction. When using used wires, we do recommend a continuity and short circuit test between each insulated connection before using it again.

24. Avoid potential equalizing currents. Please note that these currents can occur between conductive parts of a building or between conductive parts of a building and earth potential. Due to that control lines should not have electrical contact to conductive structures or parts of a building. Potential equalizing currents on the shielding of cables or on control lines can cause malfunction.

25. Please be aware of the fact that through the gas flames ionized gases are created. The thereby produced ions increase the conductivity within the air. This ionization process can cause an electrical arcing especially within the vicinity of high voltage overland cables. This may lead to lethal consequences for the user and other persons. Please note that wind conditions can be totally different a few meters above the ground.

26. Please assure that the effect can only be initiated through the operator. Keep the control unit under lock and key! Within our safety concept, all firing systems are set with individual codes, which inhibit unintended and accidental firing through third parties. If requested we can also supply systems with the same coding. This may be necessary if in a company more than one transmitter is used or when companies exchange the units between each other. It is possible to teach in the G-Flame to any PFC Advanced to enable customers to easily exchange devices.

27. With our using the key code numbers 901 and 311, we are using a standard key code, which can also be found in other products. On a customer's request we can also supply other key codes.

28. Ensure that the safety distance is maintained by all persons. The safety distance is to be enforced from the beginning of the work and maintained until the release by the responsible operator at the end of the show until the closure of the fuel supply, the burning of the fuel in the system and the shutdown of the devices.

29. In the interest of your own safety always use a sufficient length of control cable.

30. During testing and firing of the devices no persons or animals are allowed in the hazard area. Furthermore, no materials that are heat-sensitive or that can catch fire are allowed in the same.

31. When the fuel is burning carbon dioxide is generated which is a suffocative gas if the concentration in the air is sufficiently high. Due to that ensure proper ventilation. If in doubt use CO2 warning devices.

32. To burn the fuel oxygen from the air is necessary. Do not use the device if the oxygen of the air is no longer present, e.g. if carbon dioxide or nitrogen is being used to generate low fog on stages. At least from the lowest part of the burning chamber upwards a sufficient amount of oxygen must be present because otherwise the fuel cannot be ignited.

33. In applications that are critical in terms of safety you should consider safety measurements already during the setup how to safely dismantle the installation.

34. For any safety relevant questions please either contact the manufacturer or closely discuss these with the authorities in charge.

35. Use and transport the device only if the lid is closed.

36. Rehearse the planned effect and the whole course of action several times together with all people that are involved, like artists, actors, participants, technicians and staff members of the security agency etc. and ensure that all possible hazards are ruled out. If this is not possible the effect must be cancelled. Inform all participants about the function of the warning LED 'Attention, device armed' on the device.

37. Utmost care must be taken if material that can easily catch fire are present such as costumes, decoration material, fabrics or props etc.

38. If the smell of gas, leakages, flow noise or leaked fuel (gasiform or liquid) is noticed it is not allowed to put the device into operation and the hazard area has to be cleared, left and barricaded immediately. The fuel supply has to be shut off immediately in these cases.

39. Never bow over the device or put parts of your body above or respectively before the burning chamber if the device is switched on and always keep at least the safety distance that is required so that no dangerous situation can arise.

40. Avoid forces to the quick coupler in the device such as: drag forces, pushing and pulling forces and sidewise forces in all directions. If a gas hose is connected do not pull at the hose, no matter in which direction.

41. If a device did not function properly in an application it is not allowed to use it again until it has been repaired and checked by the manufacturer.

42. The system of the device must be depressurized before the cartridge holder or the hose is being removed. This is achieved by opening the magnetic valves while the fuel supply is shut off. Close the blue valves of the cartridge holder or respectively the shut-off valve of the gas bottle and fire the G-Flame again and again until no more gas is set free by the nozzle.

43. In case that the G-Flame is used to generate a continuous flame (several minutes burning time) the burning chamber and the top side of the G-Flame should be covered with suitable heat protection plates in order to prevent damages due to excessive heat. This applies to various kinds of flame bars and for the standard nozzles as well. If you have any questions regarding this topic, please contact the manufacturer.

44. This only applies to devices with a screw able micro filter: Before each use of the G-Flame, check that the O-ring of the fine filter is functional and check that the fine filter is firmly tightened so that there can be no leakage at this point. Tighten the filter housing by hand.

45. Only use original accessories. Otherwise, the safety of the equipment cannot be guaranteed. Further information can be found in the chapter 'Accessories' in the respective user manuals.

1.4 Application fields and intended use

The G-Flame is a versatile flame projector that can be used - depending on the fuel supply - outdoors, on stages, in buildings or tents.

Typical applications are:

- Flame shows outdoors, solely or combined with aerial fireworks displays or ground fireworks
- Generation of flame effects in bars, clubs or discos
- Applications on stages in buildings e.g. for TV productions or on open-air stages e.g. during a live-concerts
- Generation of flame effects in the area of special effects for TV and movie productions
- Hazard training for fire fighters, policemen, special and military forces

All other applications are considered as unintended and must be approved by the manufacturer.

The device has not been designed to produce a continuous flame. The maximum burning duration the user must mind is 25 seconds. After that the user has to pause the flame effect for at least two minutes so that the unit can cool off sufficiently. Besides long-lasting continuous flame columns are much less dramatic compared to short flame balls and flame columns.

1.5 Required approvals

Before the device can be used, a permit by the owner and if applicable of the tenant of the property or building is required.

For the usage outdoors - if it is not a stage or a place of public assembly - no permit of any authority is required to the best of the manufacturer's knowledge. Usually no charges can be imposed for this kind of usage.

In places of public assembly and on stages the relevant local laws must be followed. The necessary fire precautions must be negotiated with the competent authority for fire prevention depending on the individual case.

2 Illustration and description of indicators and control elements

2.1 Main unit



1	Antenna	This standard antenna is included in the delivery of the Advanced wireless communication module.
2	Socket 'Antenna'	This feed-through is included in the delivery of the Advanced wireless communication module.
3	Burning chamber	The nozzle is integrated in the bottom of the burning chamber, beneath the ignition electrodes. Furthermore, a drain for the rain water is installed in there.
4	Ionization electrode	This electrode is used for the flame monitoring.
5	Electrode cage	This cage encloses the ignition electrodes. It is open on the bottom so that the electrodes are accessible for cleaning.
6	Main switch	Switch the device on and off here.
7	Charging input (recessed)	Connect the charging unit here.
8	Voltage control input (recessed)	Control input for control voltages ranging from 12 to 24V DC.
9	Firing key input (recessed)	Control input for a potential-free electrical contact.
10	Output for DMX512 and RS485 (recessed)	Either used to daisy-chain the signal to the next device or to insert a connector with a network termination resistor.
11	Input for DMX512 and RS 485 (recessed)	Used to feed in the signal of the DMX console or the PFC Advanced or the device preceding in the network.
12	Emergency Off Input (recessed)	Input for the emergency switch.
13	LC Display	Displays the current information.
14	LED 'Operation'	This blue LED is continuously on if the device is in the menu and it is flashing if the device is in receiving mode or ready to fire.
15	LED 'Flame'	This yellow LED is continuously on if a flame is being generated and it is flashing if a step delay is being processed.
16	LED 'Charging'	This green LED is lit if the device is being charged.
17	LED 'Low Battery'	If the battery is discharged below 30% this red LED is flashing in receiving mode or if the device is ready to fire.
18	Magnetic sensitive area 'Up'	By pointing to this area with the magnetic pen the parameter of the current menu item will be increased or changed. If you point on this field for a longer time the parameter will increase automatically.
19	Magnetic sensitive area 'Down'	By pointing to this area with the magnetic pen the parameter of the current menu item will be decreased or changed. If you point on this field for a longer time the parameter will decrease automatically.

20	Magnetic sensitive area 'Mode'	By pointing to this area for some time, you will enter the menu. If you point to this field for a longer time, you will step through the different menu items automatically. At the end you will return to the receiving or stand-by (ready to fire) mode again.
21	Warning LED	Flashes in red color if the device is armed or while the safety timer is counting down. Can be disabled in the menu.

<p>CAUTION</p>  <p>2.4.5 2.5.1</p>	<p>Strong heating of the device during operation</p> <p>During operation, the following parts of the device can heat up considerably:</p> <ul style="list-style-type: none"> • the casing, in particular the parts forming the combustion chamber • the electrode cage • the ignition electrodes • the electrode for ionization measurement <p>Do not touch these parts until they have cooled down sufficiently and the unit is switched off.</p>
--	---

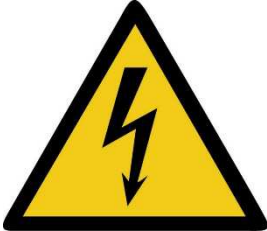
<p>WARNING</p>  <p>2.3.3</p>	<p>High ignition voltage</p> <p>For the operation of the ionization measurement and the electrical ignition of the fuel, very high voltages are generated in the device, which can be life-threatening.</p> <p>Therefore, always operate the unit with the cover panel closed and never reach into the interior of the unit or into the ignition electrodes or electrode cage during operation.</p> <p>The electrode for ionization measurement is live while the fuel valves are open. However, a current limiter in the unit prevents any danger from arising.</p>
--	---

2.2 Carrying handle

This carrying handle is located on the side of the housing opposite the inputs.

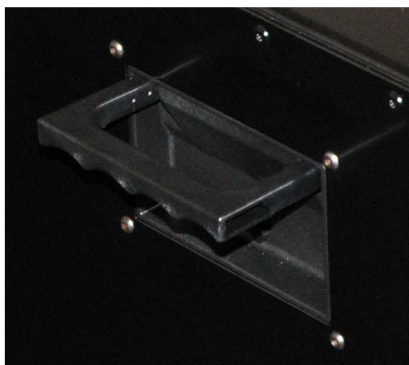

To carry the unit, unfold this handle and grasp the handle with one hand and with the other hand under the edge of the housing at the inputs on the opposite side of the unit.

Fold the handle back in when you no longer need it.

2.3 Cover panel

The cover plate is located on one side of the housing. By pressing the release-button, the connection for the gas hose or the cartridge holder and the four nozzle holders become accessible. To close it, insert the cover plate into the guides on the bottom and press it until the release button engages.

2.4 Cartridge holder

This T-shaped cartridge holder is included in the delivery of the gas cartridge option:

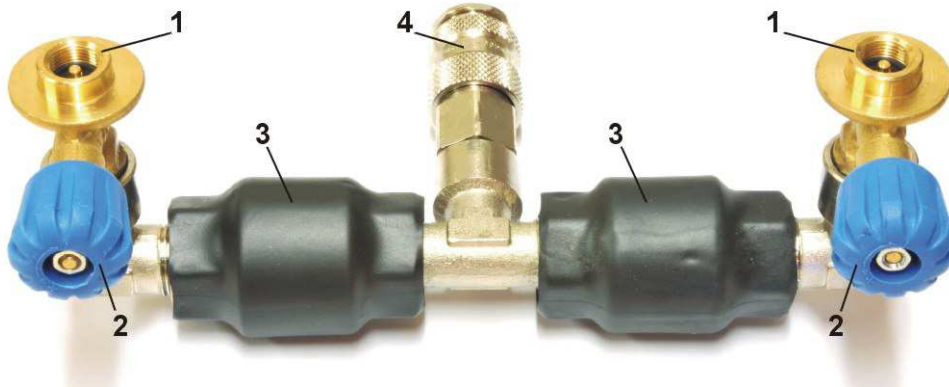

1	Reception for gas cartridges	Screw in the cartridges here. The thread is right-handed.
2	Shut-off valve	Opens or closes the fuel supply between cartridge and device. Can also be used to throttle the fuel flow to some extent to reduce the flame height.
3	Non-return valve	Ensures that no fuel will be able to escape if the shut-off valve on the other side is not closed.
4	Quick-coupler	To be connected with the opposing quick-coupler of the device. Can be released by pulling back the knurled ring.

<p>DANGER</p>  <p>2.3.8</p>	<p>Use of non-original accessories or operation without specified components</p> <p>The safe operation of the device cannot be guaranteed, if non-original accessories and components are used. All specified parts must be used to operate the device (e.g. pressure reducer).</p> <ul style="list-style-type: none"> • Use only components and accessories approved by the manufacturer. • Use all components specified by the manufacturer
---	--

3 Nozzles for different types of fuel

Different nozzles have been developed for the various types of fuels. The nozzles have been optimized for:

- perfect ignition behavior
- aesthetic flame shape
- rapid extinguishing of the flame to enable fast step sequences
- best performance of the flame monitoring system

Make sure that you use the correct nozzle for your application every time you operate the device. The usage of other nozzles than the original ones is prohibited.

The following nozzles are available:



This nozzle is intended to be used with gas cartridges.

To gain different flame heights this nozzle is available in these different sizes: S / M / L / XL / XXL

The size XXL is included in the delivery of the gas cartridge option.



This type of nozzle is must be used together with gas bottles if the gasiform phase is being used. It is included in the delivery of the gas bottle option.

Different sizes are not being offered because the flame height can be changed by adjusting the pressure setting at the pressure regulator.



This nozzle has been designed for the usage in conjunction with gas bottles if the liquid phase is being used. It is not included in the delivery of the gas bottle option and must be ordered separately if required. This kind of usage is at one's own risk.

Different sizes are not offered because for this kind of application normally a very high flame is desired and the flame height can be adjusted at the regulator. Please note that special regulators are necessary for the liquefied phase and please read the instructions given in the section 'Approved fuels and instructions if the gas bottle option is being used'.

<p>CAUTION</p>  <p>2.3.5</p>	<p>Operation without nozzle</p> <p>A flame column without a nozzle can cause an unexpected flame column.</p> <ul style="list-style-type: none"> • Use only the nozzles provided by the manufacturer.
--	--

<p>DANGER</p>  <p>2.3.8</p>	<p>Use of non-original accessories or operation without specified components</p> <p>The safe operation of the device cannot be guaranteed, if non-original accessories and components are used. All specified parts must be used to operate the device (e.g. pressure reducer).</p> <ul style="list-style-type: none"> • Use only components and accessories approved by the manufacturer. • Use all components specified by the manufacturer
---	--

3.1 Changing the nozzles and nozzle holder

The nozzles have always to be screwed in with the supplied Teflon seal.

When changing the nozzles, be sure to tighten them hand-tight (0.7 Nm torque)

NOTICE	Do not use more than 1.0 Nm torque as this will destroy the seal.
---------------	---

Holder for up to four nozzles can be found in the housing of the G-Flame.

3.2 Sealing of the nozzles or respectively of the nozzle thread

The nozzles for gas can operation have a central drilling. After use, you should cover this nozzle opening with insulating tape, preventing objects from entering the device. This is particularly the case if the device is stored or transported unpacked.

If you unscrew the nozzle and do not install another nozzle, you should also cover the opening so that no objects can enter. In such a case, we recommend that you screw in a dummy plug instead.

4 The various inputs and their compatibility and usage, pin assignments of connectors

4.1 The emergency off input

A shielded cable with two stranded wires that are wired to an electrical switch can be connected here. The emergency off switch should be installed in an enclosure. Industrial grade emergency off switches, suitable housings, cables and accessories are available on the market for do-it-yourself constructions. Upon request we can also supply this material or offer a ready-for-use solution.

Several G-Flames should always be controlled by separated emergency off switches to avoid potential equalizing currents. If you want to control several G-Flames with a single emergency off switch we can offer you a customized solution with an optical isolator between the individual signals.

The pin assignment of the emergency off input is as follows:

Pin1 = Shielding for the control signal, to be connected with the shielding of the cable
Pin2 = to be connected with the contact of the electrical switch (output at the G-Flame)
Pin3 = to be connected with the contact of the electrical switch (input at the G-Flame)

A connection diagram is printed on the housing of the G-Flame.

4.2 Firing key input

The firing key input requires a potential-free electrical contact. Contact debouncing has been implemented in hardware and software. The contact must be able to withstand a switching current of at least 100 mA at a voltage of 5V DC.

This input should always be used together with a shielded cable, especially with longer cable lengths.

The firing key input of several devices must not be connected among themselves to avoid equalizing currents caused by different potentials. Instead either galvanically isolated keys must be used or, if several devices should be controlled by a single key a customized solution with a galvanic isolator must be used.

A 3pin XLR socket is installed in the G-Flame for this input. The pin assignment is as follows:

Pin1 = Ground/Shield, to be connected with the shielding of the cable
Pin2 = Output with a voltage of 5V DC with internal current limiter; this pin needs to be connected with the electrical contact of the firing key
Pin3 = Input, 0 or 5V DC, this pin needs to be connected with the electrical contact of the firing key

A connection diagram is printed on the housing of the G-Flame.

You may also use the firing keys which are offered by us as an accessory part for the PFC Advanced. The pin assignment is identical.

If desired we will manufacture firing key according to your requirements, e.g. firing keys with long cables or foot switches.

4.3 Voltage input 12-24V

This input is intended to be used in conjunction with a Galaxis receiver or other firing modules.

The following Galaxis receivers can be used:
 PFE Profi 3 Outputs and PFE Profi 10 Outputs
 PFE Advanced 10 Outputs

Connect the positive output of the receiver with the red female input connector and the negative output (ground) with the black female input connector.

The voltage input of several devices must not be connected among themselves to avoid equalizing currents caused by different potentials. Instead either galvanically isolated outputs must be used or, if several devices should be controlled by a single voltage signal a customized solution with a galvanically isolated outputs must be used.

If using receivers of the Profi series you can select two different control durations (0.5 and 2.6 seconds). It is possible to initiate a firing cue several times one after another to generate several consecutive flame effects. In addition, you can re-fire the firing cue while the output of the receiver is active to prolong the flame effect. With receivers of the Profi series it is not possible to program more than one firing cue to one specific output.

If using receivers of the Advanced series with 10 outputs and Terminal function you may program as many firing cues as required to each output and furthermore you can individually program the duration how long the outputs should be active. This requires that the receiver is operated in 10 output mode. Further explanation regarding the usage of the Terminal function can be found in the operation manual of the PFE Advanced 10 Outputs.

If connecting other firing systems, you have to pay attention that these devices have a DC output voltage ranging between 12 and 24 Volts. Higher voltages can probably damage the input of the G-Flame. In addition, the equipment to be connected should not use capacitor buffered outputs and be able to deliver a constant voltage. If you will be able to influence the duration of the flame effects depends on the scope of operation of the control devices to be connected.

If necessary, we are able to deliver accessory parts like banana plugs and control cables if you inform us about your requirements. You can consult us regarding the technical suitability of other control components.

4.4 Charging

To charge the device connect it to the supplied charging unit and establish mains supply. The charging unit comes with a universal voltage input and can therefore be operated worldwide. All you might need are adapters for the different national standards of wall outlets.

If the accumulator needs a full charge 30h are required. The intelligent charging circuit switches to trickle charge afterwards. The device should be charged continuously while being stored. This way it is 100% at your disposal all the time. Damages from overcharging cannot occur.

The LED 'Charging' is active in green color while the battery is being charged.

<p>NOTICE</p> <p>2.6.1</p>	<p>Charging the device</p> <p>The device may only be charged in certain positions.</p> <ul style="list-style-type: none"> - Charge only the device in a horizontal position or - Charge only the device lying on its side
-----------------------------------	--

TIP

Continuous operation is possible by constantly charging the device.

TIP

After incomplete charging, a slightly higher battery capacity is displayed because the battery voltage has not yet normalized. Wait for an operating time of approx. 10 minutes to measure realistic values

4.5 Operation with DMX512

4.5.1 The DMX512 input

The DMX512 input complies with the DMX standard from 1990 respectively the standard which is defined in DIN56930-2.

The device is equipped with a 5pin female XLR jack as an input and a 5pin male XLR jack as an output to connect a DMX cable and to feed the signal to the next DMX device.

A connector with a termination resistor of 110 Ohm must be installed at the last device in the DMX line.

Up to 32 DMX devices can be operated in a single DMX line. If this is not sufficient you need to use a DMX splitter.

Please note that for DMX signals only shielded twisted-pair cables with lowest possible capacitance and an impedance of 110 Ohm are allowed to be used. Only used cables that are specified according to the DMX standard. E.g. normal microphone cables are in no case suitable for this purpose.

The pin assignment is as follows:

- Pin1 = Shield, to be connected with the shielding of the cable, also ground for wireless DMX pens
- Pin2 = Signal -
- Pin3 = Signal +
- Pin4 = unassigned but connected with the same pin on the other jack (to enable the feedthrough of return signals) or +5VDC power supply for wireless DMX pens
- Pin5 = unassigned but connected with the same pin on the other jack (to enable the feedthrough of return signals)

A connection diagram is printed on the housing of the G-Flame.

If DMX has been selected as an input in the menu of the device you may optionally activate the power supply for wireless DMX pens. This enables the autarkic operation also in the DMX mode which means that the device is independent from any cables, power supplies and fuel pipes or hoses.

Please refer to the section 'The menu' which describes the operation in DMX mode in detail.

Attention: The DMX protocol is considered to be unsafe because no checksum is being transmitted. Usually it is not allowed to control pyrotechnic effects or similar with DMX. The user solely bears the risk of any potential damages caused by a malfunction. To improve safety, we have implemented the arming of the device by using a safety channel in the G-Flame.

TIP

For the reason of safety, the G-Flames should always be operated in an exclusive DMX universe, that is only used for the flame effects and no other devices. On all unused DMX channels, the dimming value 0% (decimal 0) should be transmitted.

4.5.2 Control via DMX512

In order to generate a flame a dimmer value ranging from 60% to 80% must be transmitted on the safety channel. This is equivalent to the decimal values from 153 to 204.

First the safety condition must be met before the flame channel can initiate the generation of a flame!

The safety condition is only correctly fulfilled if the dimmer value of the flame channel is below 6% (below decimal 15) during the rising edge of the dimmer value of the safety channel.

A flame will be generated if the safety condition is met and the flame channel is being received with a dimmer value of at least 90% (at least decimal 229).

Another flame effect can only be triggered if the dimmer value of the flame channel dropped below 6% (below decimal 16) in the meantime.

If a flame is being generated currently and the safety channel is being received with a dimmer value higher than 80% or lower than 60% the electromagnetic fuel valves are closed to stop the flame effect.

It can be meaningful to program the G-Flames with different flame channels and a common safety channel. If you move the fader of the safety channel beyond the valid range all G-Flames will be deactivated together. It is still possible to program groups of safety channels if necessary.

Examples of the display content while receiving DMX signals:

```
Input: DMX512
F:003-, S:012x
```

The G-Flame has been programmed to flame channel 3 and safety channel 12 ('F' = Flame channel, 'S' = Safety channel). In addition, you see the status of the safety channels and respectively of the DMX reception. 'x' means that no signal is being received or that the transmitted value of the safety channel is not between 60% and 80% (= device is not armed). The safety condition is not met in this example and no flame is being generated.

```
Input: DMX512
F:003-, S:012✓
```

'✓' right next to the safety channel means that a DMX signal is being received and a value between 60% and 80% is being received for the safety channel (= device is armed). Consequently, flame effects can be initiated.

```
Input: DMX512
F:0030, S:012✓
```

The safety condition is fulfilled and the flame channel is being received with a dimming value of at least 90%. The G-Flame generates a flame. In this case a flame symbol is being displayed right next to the flame channel.

During the reception of DMX signals in addition to the display content shown above also the following information is being displayed alternately:

- Tilt switch on/off and the tilt status
- Flame monitoring on/off

As soon as the DMX status is changing the device immediately displays the DMX information again and the LCD backlight is switched on simultaneously if it has been enabled in the menu of the device.

4.6 Control of the device via serial data cables via the RS485 interface in conjunction with the PFC Advanced

Via the connector for the DMX signal the communication on serial data cables with the PFC Advanced is possible. DMX is only a so called protocol which is utilizing an RS485 interface.

In the menu you can choose between radio or cable control. In cable control mode the controller PFC Advanced is the feed-in to a network which has a line architecture. The controller always sends data both ways: via radio and on the cable. For this reason both control methods can be used simultaneously.

The G-Flame can receive the serial data signal on the male 5pin XLR connector and provides an output of this signal on the female 5pin XLR connector in order to feed it through to the next device.

The cable control method is using a 'RS485' network. According to this standard a termination resistor is required at the last bus device which is plugged into the unused connector. Another termination resistor has to be installed at the controller which is normally the first device in the line.

The maximum cable length of one line is 1,000 m. A 'booster' can be used to extend the length. The use of 'splitters' allows star shaped networks, too.

Serial data cables with customized lengths, termination resistors, boosters and splitters are available as accessory parts.

The maximum number of devices per line is 32. The total maximum number of devices is theoretically unlimited if boosters and splitters are being used.

If cable control has been selected in the menu the following is being displayed in receiving mode:

```
Input: Cable
(RS485 of PFC)
```

TIP

Even if the device is in cable control mode a result is displayed if a range test is in progress. The test result informs you about the range condition if you would decide to use the radio control option. A bad result of the radio range test e.g. if no antenna is connected does absolutely not imply that the signal on the cable is insufficient, too.

TIP

Feedback data from remote access functions is sent by the G-Flame on both communication carriers: via radio and on the cable. At the controller PFC Advanced you can choose which feedback signal should be detected.

The pin assignment of the RS485 interface is as follows:

Pin1 = Shielding for serial data cable, to be connected with the shielding of the cable

Pin2 = Serial data cable, Signal -

Pin3 = Serial data cable, Signal +

Pin4 = unassigned but connected between the male and female jack

Pin5 = unassigned but connected between the male and female jack

A connection diagram is printed on the housing of the G-Flame.

Upon request you will be able to receive customized data cables if you provide us your requirements.

4.7 Advanced wireless module, communication via radio or serial data cables

If the device has been equipped with the Advanced wireless module it can be controlled by the Galaxis controllers PFS Profi, PFS Pocket, PFM Advanced USB Modem and PFC Advanced. Remote data requests and remote programming is only possible if the G-Flame is used in conjunction with the PFC Advanced.

When the wireless module is installed remote data requests and remote programming is also possible with the wireless USB modem together with the Composer software from any PC or notebook.

The operation of the G-Flame together with the Advanced wireless module is described in more detail in the section 'menu' in this manual

If the wireless module is installed the G-Flame can also communicate with the PFC Advanced via serial data cables. The connection is established by using the DMX jacks and the DMX interface which in principle works as a so called RS485 interface. Please refer to the manual of the controller PFC Advanced and the receiver PFE Advanced regarding network topography and operation.

If the cable interface has been selected in the menu of the G-Flame the pin assignment of the 5pin male and female XLR connectors is as follows:

The pin assignment is as follows:

Pin1 = Shielding for serial data cable, to be connected with the shielding of the cable

Pin2 = Serial data cable, Signal -

Pin3 = Serial data cable, Signal +

Pin4 = unassigned but connected between the male and female jack

Pin5 = unassigned but connected between the male and female jack



A connection diagram is printed on the housing of the G-Flame.

Upon request you will be able to receive customized data cables if you provide us your requirements.

5 Instructions for installation and de-installation of the G-Flame

5.1 Setup of the G-Flame

First ensure that the equipment is in a safe position and observe all safety rules from the beginning of assembly to the end of disassembly. Before the G-Flame is switched on, make sure that the gas supply has been correctly established

<p>WARNING</p>  <p>2.2.1 2.3.4 2.4.1</p>	<p>Flammable atmosphere in/on the device</p> <p>When connecting or closing the gas containers, a flammable atmosphere could occur in/on the unit due to loose connections or leaks of the fuel-carrying components. An ignition spark could cause combustion or deflagration in/on the unit.</p> <ul style="list-style-type: none"> • Perform the pressure test of the fuel-carrying components as required in this operating manual • Make sure that the bottom of the device (open) is not blocked • Large recess on the underside of the unit below the fuel-carrying components, so that any escaping gas can be drained. • Do not use the unit if leaks are detected
<p>WARNING</p>  <p>2.3.6</p>	<p>Pre-ignition</p> <p>The ejected gas stream ignites too early.</p> <ul style="list-style-type: none"> • Make sure that the minimum distance to persons required in commercial stage technology is maintained. • Only connect the gas cans/bottles when the unit is switched off. • Minimize the stay in the danger area. • Activate the flame monitoring system.
<p>WARNING</p>  <p>2.2.2 2.3.7 2.4.3</p>	<p>Unintentional triggering of a flame column</p> <p>Technical faults could possibly trigger ignitions.</p> <ul style="list-style-type: none"> • Only connect the gas cans/cylinders when they are switched off.

5.1.1 Operation with aerosol cartridges

If you use aerosol cartridges, make sure that they are correctly and tightly screwed into the cartridge holder and that the shut-off valves are closed. Connect the cartridge holder to the G-Flame with the quick coupler. A clearly audible click should be heard. The shut-off valves can now be opened.

5.1.2 Operation with gas bottles

If you use gas cylinders, make sure that the gas hose is correctly and tightly screwed to the gas cylinder and that the shut-off valve is closed. Connect the gas hose to the G-Flame with the quick coupler. A clearly audible click should be heard. The shut-off valve of the gas cylinder can now be opened.

<p>WARNING</p>  <p>2.3.10</p>	<p>Use of a gas cylinder in the liquid phase with pressure reducer for the gaseous phase</p> <p>Destruction of pressure reducer or hose or uncontrolled escape of liquid gas, thereby risk of fire.</p> <ul style="list-style-type: none"> • Only use the gas cylinder in the manner approved by the manufacturer.
---	--

5.1.3 After opening

Immediately after opening the gas supply, the gas tightness must be checked. Ensure a quiet environment and pay close attention to any flow noise and use a gas leak detector to ensure that no gas is leaking. In the event of a leak, you must shut off the gas supply immediately and you must not switch on the device. Only if everything is tight, the device may be switched on.

5.2 De-installation the G-Flame

Before you de-install the G-Flame, you must burn off the fuel that is still in the system and the hoses or the cartridge holders. Proceed as follows:

<p>CAUTION</p>  <p>2.4.5 2.5.1</p>	<p>Strong heating of the device during operation</p> <p>During operation, the following parts of the device can heat up considerably:</p> <ul style="list-style-type: none"> • the casing, in particular the parts forming the combustion chamber • the electrode cage • the ignition electrodes • the electrode for ionization measurement <p>Do not touch these parts until they have cooled down sufficiently and the unit is switched off.</p>
--	---

<p>WARNING</p>  <p>2.2.1 2.3.4 2.4.1</p>	<p>Flammable atmosphere in/on the device</p> <p>When connecting or closing the gas containers, a flammable atmosphere could occur in/on the unit due to loose connections or leaks of the fuel-carrying components. An ignition spark could cause combustion or deflagration in/on the unit.</p> <ul style="list-style-type: none"> • Perform the pressure test of the fuel-carrying components as required in this operating manual • Make sure that the bottom of the device (open) is not blocked • Large recess on the underside of the unit below the fuel-carrying components, so that any escaping gas can be drained. • Do not use the unit if leaks are detected
--	--

5.2.1 Operation with aerosol cartridges

Close the shut-off valves on the cartridge holders and switch the unit on again if it is switched off. Remove the remaining gas in the G-Flame by triggering the device until no flame comes out of the combustion chamber anymore.

5.2.2 Operation with gas bottles

Close the shut-off valve on the gas cylinder and switch the device on again if it is switched off. Remove the remaining gas in the G-Flame by triggering the device until no flame comes out of the combustion chamber anymore.

5.2.3 After closing

Only now you can switch off the unit and remove the cartridge holder or hoses without pressure, because the quick connectors must always be opened without pressure so that the seals are not damaged. The unit can now be de-installed.

<p>CAUTION</p>  <p>2.4.2</p>	<p>Unexpected flame column</p> <p>Unexpected flame column on ignition without connected gas bottle/cans due to remaining residual gas in the system.</p> <ul style="list-style-type: none"> • Flame off residual gas quantities in the system.
--	--

<p>CAUTION</p>  <p>2.4.4</p>	<p>Dangerous movement of the gas hose</p> <p>The gas hose could take up a dangerous movement due to the residual pressure in the system.</p> <ul style="list-style-type: none"> • Use quick coupling systems described by the manufacturer.
--	---

5.3 Tilting the G-Flame

The tilted operation of the G-Flame is possible. We recommend a maximum tilt angle of 45° in conjunction with gas bottles and a maximum tilt angle of 75° when gas cartridges are being used.

<p>NOTICE</p> <p>2.1.1</p>	<p>Dropping the device during operation</p> <p>The unit may fall over during operation.</p> <ul style="list-style-type: none"> • Ensure that the unit is sufficiently stable. • If necessary, attach the unit to the designated mounting points. • Use only suitable stands. • Always use the tilt monitor if possible.
-----------------------------------	--

If gas cartridges are installed the liquefied phase is being used and due to that the flames follow better the tilt angle because the influence of the thermal lift on the shape of the flame is significantly lower in this case.

When the tilt angle is more than 30° the tilt sensor has to be turned off in the menu of the device. When doing so please note that the device will not close the electromagnetic valves e.g. if it is turned over. In this case it is so much more important to ensure that the G-Flame is securely mounted and that your personnel is constantly supervising that all devices are in correct position.

If the G-Flame is used with gas cartridges it can also be tilted with an angle of e.g. 90°, 135° or 180° but in these cases the problem exists that the fuel can no longer be used completely or partly in the liquefied phase. Due to that for example a short hose and an external cartridge holder is necessary to enable this operation. If you have a demand for this please contact us so that we can provide a customized solution.

5.3.1 Instructions for installation at a tilt of 180°

If you want to use the G-Flame inclined by 180°, we recommend this application exclusively with gas cartridges. To do this, you must use an extension for the gas cartridge holder (Item No. 1807). This ensures that the gas from the cartridges is still withdrawn in liquid form. This extension means that the gas cartridges can no longer be installed in the housing of the G-Flame.

5.4 Additional instructions for permanent installations

A permanent installation requires that the system is effectively and redundantly monitored by at least two gas detection devices. The function of the gas detectors has to be checked weekly. These function checks must be recorded in writing.

The amount of fuel which is held available and is connected with the device must be as low as possible.

The shut-off valves should be opened as shortly as possible before the usage and they should be closed again as fast as possible after the effects.

5.4.1 Operation with aerosol cartridges

No gas cartridges are allowed to remain in the device if no personnel is present to supervise the devices.



5.4.2 Operation with gas bottles

The fuel shut-off valves on the gas bottles must be closed if no personnel is present to supervise the devices.

5.5 Instructions regarding the use of Flame Bars

Attention: If you want to use Flame Bars, we would like to expressly state here that only gaseous fuel and under no circumstances liquid gas may be used! As a result, the conventional cartridge holder cannot be used here.

How this can best be achieved in the respective application should be clarified individually with the manufacturer.

<p>WARNING</p>  <p>2.3.11</p>	<p>Use of liquid gas</p> <p>Unexpectedly large flame at the Flame Bars, possibly dropping of burning liquid gas to the ground.</p> <ul style="list-style-type: none"> • Only use fuels approved by the manufacturer.
<p>DANGER</p>  <p>2.3.8</p>	<p>Use of non-original accessories or operation without specified components</p> <p>The safe operation of the device cannot be guaranteed, if non-original accessories and components are used. All specified parts must be used to operate the device (e.g. pressure reducer).</p> <ul style="list-style-type: none"> • Use only components and accessories approved by the manufacturer. • Use all components specified by the manufacturer.

5.6 Mounting on light or speaker stands

A receptor for the direct mounting of the G-Flame on light or speaker stands has been integrated in the bottom side of the housing.

5.7 Mounting on truss elements

Cage nuts have been integrated in the bottom of the housing to enable the direct mounting of the device on 3-point and 4-point truss elements. Depending on the shape of the truss elements you want to use you may have to remove one cage nut and insert it in another holder.

Cone shaped couplers with bolts and safety splint-pins (half cone with M10 screw), which can be inserted into the tubes of the truss elements, are available from specialized trade shops for stage equipment.

If necessary, e.g. in places of public assembly, a safety rope can be installed in addition by using the eye on one edge of the housing.

6 Approved fuels

6.1 Approved fuels and instructions if the gas bottle option is being used

Make sure that the correct nozzle for this type of fuel is installed and that it is tightened sufficiently.

Gas bottles with 5 kg, 11 kg or 33 kg of liquefied Propane/Butane gas mixture can be used with this type of operation.

For safety reasons you should use the smallest bottle possible. Only if a high quantity of gas is required for a single event you should use the next larger bottle size.

<p>DANGER</p>  <p>2.3.9</p>	<p>Use of gas cylinders without pressure reducer</p> <p>The safe operation of the device cannot be guaranteed by operating gas cylinders without pressure reducers. All prescribed parts must be used to operate the appliance.</p> <ul style="list-style-type: none"> • Only use gas cylinders with an upstream pressure reducer.
---	--

The usage of other fuels in this operation mode, e.g. with coloring additives, is strictly prohibited because this can lead to leakages in the system or malfunction of the electro-magnetic valves.

The distance between the G-Flame and the gas bottle must be at least 1.0 m. The G-Flame is not allowed to be inclined in the direction of the gas cylinder when it is in tilted operation.

6.1.1 Instructions regarding the usage of the gasiform phase

The usage that is intended by the manufacturer is that only the gasiform phase is being taken from the bottle. Here it is mandatory to use a pressure regulator and the maximum output pressure must not be higher than 4.0 bar. The used gas hose must be approved for a pressure of 6.0 bar. If you order the gas bottle option we deliver appropriate and approved equipment for this type of usage. If the inner diameter of the gas hose is too small or if the pressure regulator is unsuitable the flame height will be reduced. The usage of gas bottles without pressure regulator is an extreme accident hazard and is strictly prohibited. The reason is that the pressure in the bottle can reach up to 35 bar and certain components like e.g. the gas hose and the electro-magnetic valves have not been designed for this.

6.1.2 Instructions regarding the usage of the liquid phase

The usage that is intended by the manufacturer is that only the gasiform phase is being taken from the bottle. You can use also the liquid phase on your own risk. When using the liquid phase much higher flames can be generated (approx. 8-9 m). For doing so another nozzle is required and it is prohibited to use the supplied pressure regulator.

<p>WARNING</p>  <p>2.3.10</p>	<p>Use of a gas cylinder in the liquid phase with pressure reducer for the gaseous phase</p> <p>Destruction of pressure reducer or hose or uncontrolled escape of liquid gas, thereby risk of fire.</p> <ul style="list-style-type: none"> • Only use the gas cylinder in the manner approved by the manufacturer.
---	--

Standard pressure regulators are not suitable to be used with the liquefied phase. When the temperature is rising the pressure in the hose will increase extremely which will destroy the pressure regulator and liquefied gas is set free. Pressure regulators are offered on the market which are suitable to regulate the liquefied phase. Furthermore, a gas hose must be used that has been approved for at least the maximum bottle pressure which is 35 bar. Hydraulic hoses are suitable for this.

It must be avoided by all means that a certain volume filled with liquefied gas is blocked off. For example, it is not allowed to fill the hose with liquefied gas and then close the shut-off valve on the bottle. The pressure in the locked volume will increase with a rate of 7 bar per 1°C when the temperature is rising! If you do not use a regulator must ensure that the bottle pressure is not higher than 10 bar because this is the maximum pressure that the electromagnetic valves can handle and due to that the bottle temperature should not exceed 25°C. It is not advisable to use the liquid phase by turning the bottles upside down. Besides the fact that the bottle is no longer standing stable also dirt from the bottle may enter the regulator (if installed) or the system of the G-Flame. When using the liquid phase, you should only use bottles with a dip tube installed inside. The safety distance must be extremely increased: if there is no wind at least 10 m to the side and 20 m upwards. The safety distance sideways has to be increased in windy conditions by the judgment of the operator. Please note in this context that unburned fuel that is transported by the wind can be hazardous.

Accurately inspect all equipment before each application, especially the gas hose, regarding possible damages. It is strictly prohibited to use damaged parts or equipment.

Ensure that the gas hose cannot become damaged during usage, e.g. by burning stars from aerial shells that fall down to the ground. Fireproof protective covers for the gas hoses are available upon request.

Make sure that the flame monitoring system is enabled in the menu of the G-Flame.

The usage of gas bottles in conjunction with the G-Flame is only permitted outdoors and not on stages, in buildings or tents etc.

Before starting operation, the system has to be checked with a gas leak detector.

Make sure that the quick coupler, the gas hose and the pressure regulator is connected gas tight with the gas bottle.

Depending on your application it can be necessary to use gas detectors to ensure best possible safety. Cost effective devices are offered on the market. Please note in this context that Propane and Butane is heavier than air and due to that it can accumulate in sinks, trenches, cellars or shafts. This characteristic must be taken into consideration when installing gas detectors.

In case that the G-Flame do not ignite the fuel because of a technical defect or if the device should have a leakage the units must be turned off immediately either by using the emergency-off input or by disabling the hazard zone that has been assigned to the device and the fuel supply has to be shut off as quickly as possible. The main switch is not allowed to be used as long as an ignitable fuel-air-

mixture is present. The advantage of using the emergency-off input is that no spark, which could possibly ignite the mixture, is being generated when turning off the unit.

In most cases liquefied gas is a mixture of Propane and Butane. The mixing ratio can be very different, depending on the country. This has to do with the fact that the vapor pressure of Propane is much higher compared to Butane. In countries with a warm climate usually the Butane proportion is much higher while in countries with a colder climate the Propane proportion is higher. The mixing ratio can also vary depending in which season the gas is being purchased. The G-Flame can work with any Propane/Butane mixing ratio. You should use the liquefied gas as it is offered in the particular country instead of e.g. bringing pure Propane bottles to a region with relatively warm climatic conditions.

The instructions in the material safety data sheet of the gas bottles, the ADR regulations (i.e. regulations for the transportation of dangerous goods) and the regulations imposed by the employer's liability insurance association for the storage and usage of gas bottles and all other relevant laws, especially for places of public assembly and all accident prevention regulations, must be strictly followed. Especially the maximum allowable temperature of the bottles must not be exceeded. Protect the bottles from direct sun light and ensure that the bottles do not become overheated e.g. if they are loaded on vehicles. Usually the bottles are equipped with a pressure relief valve which opens at 35 bar with a tolerance of +/- 5 bar. This is beneficial to prevent the burst of a bottle during a fire. If the pressure is decreasing this safety valve is closing automatically. Of course, the released gas is a major accident hazard. Liquefied, pure Propane already generates a vapor pressure of 26 bar at a temperature of 70°C. 30 bar is exceeded at a temperature of 78°C and gas could possibly vent through the pressure relief valve. According to the regulations of the employer's liability insurance association already a bottle temperature of 40°C is unallowable.

The valves of the bottles should be opened as shortly as possible before the usage and they should be closed again as fast as possible after the effects.

After each usage the remaining fuel in the gas hose and in the system of the G-Flame must be emptied. To do so first close the valves of the gas bottles and then initiate a flame effect several times until no flame is being generated any more. Then the installation can be dismantled.

TIP	Expect that the G-Flame generates a flame every time you trigger the device even if there is no fuel supply. It could be that there is still fuel in the system and due to that a flame can be possibly generated. Furthermore, it could be that the system has not been completely emptied last time when the devices have been used.
------------	--

When gas is drawn from the gas bottle, which contains the liquefied phase, the liquid in the bottle is cooling down due to the evaporative heat loss. Especially if a high volume is drawn from the bottle and if the ambient temperature is low this can lead to a significant pressure loss in the bottle resulting in a lower flame height. If you want to use or construct a bottle heater to cope with this problem you must not use appliances that have not been approved for this. Furthermore, the heating device must be equipped with at least two independent temperature monitoring systems for failover redundant operation.

6.2 Approved fuels and instructions if the gas cartridge option is being used

Make sure that the correct nozzle for this type of fuel is installed and that it is tightened sufficiently.

The gas cartridge option is intended to be used for applications on stages or in buildings. It is always possible to use the G-Flame with this variant also outdoors. In this context we would like to point out that the flame effect is less susceptible to windy conditions due to the fact that the liquefied phase is being used if gas cartridges are installed.

When gas cartridges are to be used the following fuel-cartridges are approved:

a)

Manufacturer or respectively supplier:

ROTHENBERGER Werkzeuge GmbH
Industriestraße 7
65779 Kelkheim
Germany

Telephone: +49 / 6195 / 800-0
Fax: +49 / 6195 / 800-3500

e-Mail: info@rothenberger.com
Homepage: www.rothenberger.com

Product name: Multigas 300
Content: 600 ml Aerosol (330 g)
Composition: approx. 65% Butane, 35% Propane
Calorific value: 4,61 kWh / Cartridge

b)

Manufacturer or respectively supplier:

CFH Löt- und Gasgeräte GmbH
Bahnhofstraße 50
74254 Offenau
Germany

Telephone: +49 / 7136 / 95 94-0
Fax: +49 / 7136 / 95 94-44

Homepage: www.cfh-gmbh.de
e-Mail: info@cfh-gmbh.de

Product name: Universaldruckgasdose AT 2000
Content: 600 ml Aerosol (330 g)
Composition: approx. 70% Butane, 30% Propane
Calorific value: 4,61 kWh / Cartridge

Additional fuels can be approved upon request.

In this operation mode the pressurized liquid is taken from the cartridges and is atomized by the nozzle of the G-Flame. An aerosol is produced which is then ignited by an electrical arc. Due to this we are speaking of aerosol cartridges, fuel cartridges or gas cartridges.

Use only a single cartridge for the reasons of safety if you do not need to generate many flame effects.

The usage of other fuels in this operation mode, e.g. with coloring additives, is strictly prohibited because this can lead to leakages in the system or malfunction of the electro-magnetic valves.

Make sure that the flame monitoring system is enabled in the menu of the G-Flame.

Only use original accessories which you will receive from us when ordering the gas cartridge option. The cartridge adaptor consists of a T-piece with two non-return valves, two shut-off valves and two connectors for the gas cartridges. The non-return valves prevent the leakage of fuel on the other side of the T-piece if a cartridge is being installed while the shut-off valve on the other side is not closed.

Even though non-return valves are installed you have to ensure that both shut-off valves are closed when screwing in one or two cartridges.

Before removing the T-piece from the G-Flame or before screwing in fuel cartridges you have to ensure that no ignition sources are present in the surrounding area. Smoking and open fire is forbidden. All other sources of ignition must be eliminated.

Make sure only to use cartridges that are undamaged and that the connectors for the cartridges and the thread on the cartridges is free from dirt and dust.

Open the cover lid of the G-Flame in order to screw in the cartridges and remove the T-piece by opening the quick-coupler. To do so pull back the knurled ring. Check all parts of the equipment thoroughly if anything is damaged, especially the seal in the quick-coupler of the T-piece. It is strictly prohibited to use damaged equipment.

Pay attention to screw in the cartridges gas-tight, completely and rather tight. Otherwise it is possible that the valve in the cartridges is not completely opened which leads to the problem that the fuel amount that can be drawn from the cartridge is reduced. In this case either the flame height will be reduced or the flame cannot be ignited. Both can cause a shut-off of the electromagnetic valves because the flame monitoring system cannot detect a sufficiently burning flame.

The shut-off valves in the T-piece should be opened as shortly as possible before the usage and they should be closed again as fast as possible after the effects.

Before or respectively while putting the device into service it can be reasonable to check the whole system with a gas leakage detector. If used on stages, buildings or tents this is absolutely necessary. When screwing in the cartridges it can happen that a small amount of fuel is set free. Due to the fact that gas leakage detectors are very sensitive you should wait some minutes so that the fuel that was possibly released when the cartridge was installed can evaporate and volatilize completely. Then you can begin with the testing against leakages.

If it should be the case that G-Flames do not ignite the aerosol spray or that there is a fuel leakage because of a technical defect the units must be turned off immediately either by using the emergency-off input or by deactivating the hazard zone that has been assigned to the device and the fuel supply has to be terminated as fast as possible. The unit may only be turned off by using the main switch if you can assure that there is no inflammable or explosible fuel-air ratio present. The advantage of utilizing the emergency-off input is that during the shut-down no electric spark can be generated that could ignite a fuel-air mixture.

Depending on your application it can be necessary to use gas detectors to ensure best possible safety. In applications on stages, in buildings or tents this is mandatory. Cost effective devices are offered on the market. Please note in this context that Propane and Butane is heavier than air and due to that it can accumulate in sinks, trenches, cellars or shafts. This characteristic must be taken into consideration when installing gas detectors.

Gas cartridges contain predominantly Butane, which has a lower vapor pressure compared to Propane. Furthermore, the vapor pressure curve of Butane has a much flatter characteristic. On the other hand, the cartridge is by far not so robust as a gas bottle. Therefore, the maximum temperature, which is 50 °C according to the guidelines provided by the manufacturers of the cartridges, must not be exceeded during storage, transportation and usage.

The instructions in the material safety data sheet of the gas cartridges, the ADR regulations (i.e. regulations for the transportation of dangerous goods) and the regulations imposed by the employer's liability insurance association for the storage and usage of gas cartridges and all other relevant laws, especially for places of public assembly and all accident prevention regulations, must be strictly followed. Especially the maximum allowable temperature of the gas cartridges must not be exceeded. Protect the cartridges from direct sun light and ensure that the cartridges do not become overheated e.g. if they are loaded on vehicles.

After each usage the remaining fuel in the T-piece and in the system of the G-Flame must be burned off. To do so first close the shut-off valves on the T-piece and then initiate a flame effect several times until no flame is being generated any more. Then the installation can be dismantled. In this context we

want to point out that it can take very long until the liquid fuel in the system has completely evaporated. When the liquid fuel evaporates a lot of coldness is being generated (evaporation chill) and this leads to a deceleration of the evaporation. Due to that it can absolutely happen that after a certain time a flame is being generated again even though it seemed that the fuel evaporated completely when emptying the system.

After emptying the system and burning off the fuel the installation can be dismantled. Before your remove the T-piece you have to make sure that no ignition sources are present.

TIP	Expect that the G-Flame generates a flame every time you trigger the device even if there is no fuel supply. It could be that there is still fuel in the system and due to that a flame can be possibly generated. Furthermore, it could be that the system has not been completely emptied last time when the devices have been used.
------------	--

6.3 Fuel consumption

6.3.1 Fuel consumption if gas bottles are being used

With a gas bottle with a content of 11 kg approx. 1,000 flame effects with a duration of 0.5 seconds and a height of 5 m can be generated. With a 5 kg bottle approx. 450 of these effects are possible.

6.3.2 Fuel consumption if gas cartridges are being used

The fuel consumption depends mainly on the vapor pressure in the gas cartridges which depends on the temperature and also the nozzle size has an effect on the amount of fuel consumed.



The following spreadsheet should give you approximate guideline values. The information in seconds refers to the approximate total burning duration with two cartridges with different cartridge temperatures. The burning duration has been determined by using cartridges with a content of 330 g or respectively 600 ml.

Nozzle size	S	M	L	XL	XXL
-20 to -15°C	62 Sec.	57 Sec.	52 Sec.	47 Sec.	42 Sec.
-15° to -10°C	60 Sec.	55 Sec.	50 Sec.	45 Sec.	40 Sec.
-10° to -5°C	58 Sec.	53 Sec.	48 Sec.	43 Sec.	38 Sec.
-5° to 0°C	56 Sec.	51 Sec.	46 Sec.	41 Sec.	36 Sec.
0° to +5°C	54 Sec.	49 Sec.	44 Sec.	39 Sec.	34 Sec.
+5° to +10°C	52 Sec.	47 Sec.	42 Sec.	37 Sec.	32 Sec.
+10° to +15°C	50 Sec.	45 Sec.	40 Sec.	35 Sec.	30 Sec.
+15° to +20°C	48 Sec.	43 Sec.	38 Sec.	33 Sec.	28 Sec.
+20° to +25°C	46 Sec.	41 Sec.	36 Sec.	31 Sec.	26 Sec.
+25° to +30°C	44 Sec.	39 Sec.	34 Sec.	29 Sec.	24 Sec.
+30° to +35°C	42 Sec.	37 Sec.	32 Sec.	27 Sec.	22 Sec.
+35° to +40°C	40 Sec.	35 Sec.	30 Sec.	25 Sec.	20 Sec.

30 seconds would be for example 100 short flame effects with 0.3 seconds each or 60 flame effects with 0.5 seconds each or 30 flame columns with a valve opening duration of 1.0 seconds.

7 Safety distances

The safety distances stated in this manual refer to flame retardant materials. For other materials or objects that are susceptible to heat the safety distances must be significantly increased. The thermal output of this effect device is enormous. It is more than 1.2 Megawatt if gas cartridges are being used at a cartridge temperature of 20°C. Especially the safety distance upwards must be increased by 3 m if easily inflammable materials are present.

<p style="text-align: center;">DANGER</p>  <p style="text-align: center;">2.3.1</p>	<p>Open flame column</p> <p>Due to the open flame column caused by the operation, personal injury can occur.</p> <ul style="list-style-type: none"> • Make sure that the minimum distance to persons required in commercial stage technology is maintained. • Minimize the stay in the danger zone.
<p style="text-align: center;">WARNING</p>  <p style="text-align: center;">2.3.6</p>	<p>Pre-ignition</p> <p>The ejected gas stream ignites too early.</p> <ul style="list-style-type: none"> • Make sure that the minimum distance to persons required in commercial stage technology is maintained. • Only connect the gas cans/bottles when the unit is switched off. • Minimize the stay in the danger area. • Activate the flame monitoring system.
<p style="text-align: center;">WARNING</p>  <p style="text-align: center;">2.3.2</p>	<p>Ignition failure</p> <p>The ejected gas stream does not ignite.</p> <ul style="list-style-type: none"> • Make sure that the minimum distance to persons required in commercial stage technology is maintained. • Minimize the stay in the danger zone. • Activate the flame monitoring system.

The required safety distance for safe operation is depending on several parameters. The flame height is influenced by different nozzle sizes if gas cartridges are being used and by the selected output pressure of the pressure regulator if gas bottles are being used. Furthermore, wind and every other air movement and the thermal lift are relevant factors.

The duration how long the electromagnetic fuel valves are opened is having an influence on the required safety distance. If the valves are opened for extremely short times (approx. 0.1 to 0.5 seconds) smaller flame balls are being generated compared to longer durations.

In addition, the temperature of the gas cartridges or gas bottles is affecting the flame height.

The pressure in the gas cartridges is rising with the temperature. Due to the lack of a pressure regulator the flame height depends directly on the temperature of the fuel in the cartridges.

If gas bottles are used the output pressure of the regulator is constant and therefore the flame height is actually not depending on the temperature of the bottle unless the liquefied gas is very cold or is chilled by the evaporative heat loss so that the vapor pressure in the bottle is falling below the selected output pressure of the regulator. Propane has a vapor pressure of approx. 4 bar at 0°C and approx. 2 bar at -15°C.

Wind or thermal influences may heighten the effects which can demand increased safety distances as well.

In general, the following rule applies: The operator is responsible for the accident-free usage of the G-Flame and has to decide by his own judgment which safety distance is required.

In certain circumstances the safety distances may be specified by the authorities that are responsible for the safety during the fire prevention assessment on site. The following tables should inform you about the effect height to be expected and be an orientation guide when specifying the minimum safety distances.

In general, all the recommendations for the safety distances given in here are basing on the condition that there is no wind at all! Windy conditions will lead to the result that the effects are drifting sideways accordingly, especially if gas bottles are being used. This must be considered when choosing the position for the installation, choosing a nozzle size and the operation pressure. Due to the fact that the usage of the devices is beyond our control expressly disclaim any liability for any damages resulting from insufficient safety distances. Therefore, we are only giving recommendations regarding the safety distances instead of fixed values. Every user must decide by himself which minimum safety distance is required for his application.

Utmost care must be taken if actors are wearing costumes that are easily inflammable. In such cases the safety distance must be increased dramatically. If in doubt the effect has to be omitted.

7.1 Safety distances if gas bottles are being used, device standing vertically

Selected pressure [bar]	0,0 - 0,5	0,5 - 1,0	1,0 - 1,5	1,5 - 2,0	2,0 - 2,5	2,5 - 3,0	3,0 - 3,5	3,5 - 4,0
Approx. effect height* [m]	1,5	2,0	2,5	3,0	3,5	4,0	4,5	5,0
Safety distance upwards** [m]	3,5	4,0	4,5	5,0	5,5	6,0	6,5	7,5
Safety distance sideways*** [m]	2,0	2,0	2,5	2,5	3,0	3,0	3,5	3,5

* = Expected effect height if valves are opened for 1.5 seconds if G-Flame is standing vertically

** = Recommended safety distance upwards to persons, animals or flame retardant objects

*** = Recommended safety distance sideways to persons, animals or flame retardant objects

7.2 Safety distances if gas cartridges are being used, device standing vertically

Nozzle size	S	M	L	XL	XXL
-20 to -10°C	approx. 1.5 m	approx. 2.0 m	approx. 2.5 m	approx. 3.0 m	approx. 3.5 m
	3.5 m	4.0 m	4.5 m	5.0 m	5.5 m
	2.0 m	2.0 m	2.0 m	2.5 m	2.5 m
-10 to 0 °C	approx. 2.0 m	approx. 2.5 m	approx. 3.0 m	approx. 3.5 m	approx. 4.0 m
	4.0 m	4.5 m	5.0 m	5.5 m	6.0 m
	2.0 m	2.0 m	2.5 m	2.5 m	2.5 m
0 to 10 °C	approx. 2.5 m	approx. 3.0 m	approx. 3.5 m	approx. 4.0 m	approx. 4.5 m
	4.5 m	5.0 m	5.5 m	6.0 m	6.5 m
	2.0 m	2.5 m	2.5 m	2.5 m	3.0 m
10 to 20 °C	approx. 3.0 m	approx. 3.5 m	approx. 4.0 m	approx. 4.5 m	approx. 5.0 m
	5.0 m	5.5 m	6.0 m	6.5 m	7.0 m
	2.5 m	2.5 m	2.5 m	3.0 m	3.5 m
20 to 30 °C	approx. 3.5 m	approx. 4.0 m	approx. 4.5 m	approx. 5.0 m	approx. 5.5 m
	5.5 m	6.0 m	6.5 m	7.0 m	7.5 m
	2.5 m	2.5 m	3.0 m	3.5 m	4.0 m
30 to 40 °C	approx. 4.0 m	approx. 4.5 m	approx. 5.0 m	approx. 5.5 m	approx. 6.0 m
	6.0 m	6.5 m	7.0 m	7.5 m	8.0 m
	2.5 m	3.0 m	3.5 m	4.0 m	4.5 m

Marking in cyan color = Expected effect height if valves are opened for 1.5 seconds if G-Flame is standing vertically

Marking in yellow color = Recommended safety distance upwards to persons, animals or flame retardant objects

Marking in green color = Recommended safety distance sideways to persons, animals or flame retardant objects

It can be necessary to increase the safety distance to uninvolved persons significantly also to ensure that these people do not become frightened and do not show panic reactions. Our recommendation is here a safety distance of at least 5 m sideways.

7.3 Safety distances when using flame bars

The safety distances when using Flame Bars are 2.5 m upwards from the pipe in all directions and 2.0 m from the pipe ends to the side.

7.4 Safety distances if the device is being tilted

It is also possible to mount the device in a tilted orientation. If gas bottles are being used, we recommend a maximum tilt angle of 45° sideways. When operated with gas cartridges the maximum tilt is 75° sideways.

If the device is operated with a tilt angle the safety distances sideways in the direction of the tilt angle should be increased according either to the operator's judgment or to the guidelines of the authorities. Possibly the safety distances on the other side can be reduced, but we recommend to keep at least a minimum distance of 2.0 m.

We recommend to keep the minimum safety distance upwards to people, animals and flame retardant materials if the device is being tilted because due to the thermal lift the same amount of heat will ascent.

7.5 Safety distances if the device is mounted above the spectators

In general, it is possible to install the devices above the spectators, e.g. on elevated truss elements. The device does not have any fall-out but we recommend a minimum safety distance to people, animals and flame retardant materials of 2 meters above the heads of the spectators. If the devices are used above the spectators you have to take into consideration that they can become frightened and could possibly show panic reactions. This bears the risk of injury and death.

7.6 Reduction of the safety distances to actors

Possibly the safety distance to performers (actors, musicians, Stuntmen, artists, etc.) can be reduced slightly if these persons have been well trained and became familiar with the flame effect. It can be necessary to employ other safety measures such as flame retardant or inflammable costumes, pyrotechnical barrier gel (i.e. stunt gel) for the unprotected skin, etc. The user who is in charge for the safety will also have to take into consideration that heat is being dissipated as infrared radiation (invisible heat radiation) and that heat is rising upwards due to the thermal lift.

8 Switching on

The G-Flame can only be operated if the emergency switch is closed. If you want to use the device without emergency switch you can plug in the supplied XLR connector which is bridging the contacts of the emergency switch before you put the device into operation. In principle the main switch and the emergency switch are wired in series.

To switch on the G-Flame press the main switch which you will find on the side of the device where the display is.

Firstly, on the LCD the start screen and the firmware version is being displayed:

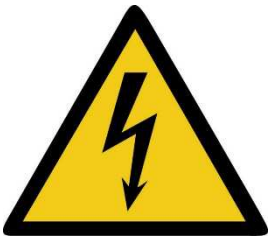

Right after that the safety timer is started, unless a warning message is being displayed that the battery has been deeply discharged.

<p>WARNING</p>  <p>2.3.3</p>	<p>High ignition voltage</p> <p>For the operation of the ionization measurement and the electrical ignition of the fuel, very high voltages are generated in the device, which can be life-threatening.</p> <p>Therefore, always operate the unit with the cover panel closed and never reach into the interior of the unit or into the ignition electrodes or electrode cage during operation.</p> <p>The electrode for ionization measurement is live while the fuel valves are open. However, a current limiter in the unit prevents any danger from arising.</p>
---	---

9 Information regarding the firmware version

Version 2.2: The first devices that have been sold have been shipped with this version
 With version 2.3: The splash screen and menu texts have been changed

10 Battery monitoring and warning message 'deep discharge' after powering up the device

The rechargeable battery is monitored during operation. If the battery is being deeply discharged while the device is in receiving mode or ready to fire mode this event is stored in the memory of the device and each time when you switch on the G-Flame you will see a warning message.

TIP	Deep discharges can only be detected if the device is in receiving mode or respectively in ready to fire mode.
------------	--

In case of a deeply discharged battery you see e.g. this being displayed and during that an acoustic signal will be given:

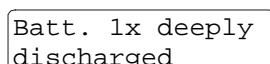

The number of deep discharges is being displayed here. The safety will be automatically started after five seconds.

In such cases we recommend to do a battery capacity measurement occasionally to determine if the battery has probably been damaged. Please refer to the menu item 'Start Battery Measurement?'. Please note that deep discharges in general lead to a reduced life time of the batteries.

If the battery shows bad capacity results you can order a new battery at all times from us and replace it yourself.

If you have replaced the battery yourselves you also can reset the warning message described above. Please read below how to achieve this.

10.1 Resetting the warning message 'Battery deeply discharged'

You can reset this warning message after you have installed a new battery. For doing so activate the magnetic sensor field 'Up' while the warning message is being displayed.

```
Reset deep
discharges...
```

Right after that you will see this being displayed on the LCD screen.

Then the following text will be displayed as a ticker:

```
Call the Galaxis office and tell the token. You will
receive the activation code. Continue with Mode.
```

If you now activate 'Mode' a random eight-digit sequence of numbers will be generated and displayed, the so-called token. Tell us this token on the phone and will give you the corresponding activation code.

TIP

You may speed up the ticker by activating the 'Mode' sensor field and keeping it activated.

The sequence is as follows:

```
Token :
53582820
```

Example of a token being displayed. This screen is being displayed sufficiently long so that you can tell us the token on the phone.

```
Code?
◆
```

Then you see this request to enter the activation code which you will receive from Galaxis on the phone. With 'Up' and 'Down' you can change the digits. If you see the correct number being displayed activate 'Mode' to proceed. A '0' can be entered the easiest by activating 'Mode' without activating 'Up' or 'Down' before.

```
Code?      OK
44232502◆
```

The activation code, which has also eight digits, has been accepted and the deep discharge counter has been reset to zero. No more warning message will be displayed any more until the next occurrence.

```
Code?      X
5423250200◆
```

A wrong activation code has been entered and the code was not accepted. Switch off the G-Flame and repeat the procedure.

11 Safety timer

The safety timer will be started every time when the device is powered up and after exiting the menu.

```
Safety Timer
Armend in: 15s
```

The timer counts down 15 seconds.

The purpose of the safety timer is that the user can step back from the device before a flame effect can be initiated.

The safety timer will be started no matter which control method has been selected.

Note: While the safety timer is counting down you can terminate the sequence and directly invoke the menu by activating 'Mode'.

12 The warning LED 'Attention armed'

On one side of the housing where also the display and the connectors can be found there is also a warning indicator in the shape of an exclamation mark.

This warning LED should alert people in the surroundings of installed devices that flame effects will be possibly initiated.

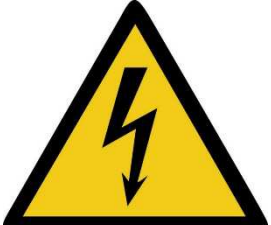
<p>WARNING</p>  <p>2.3.3</p>	<p>High ignition voltage</p> <p>For the operation of the ionization measurement and the electrical ignition of the fuel, very high voltages are generated in the device, which can be life-threatening.</p> <p>Therefore, always operate the unit with the cover panel closed and never reach into the interior of the unit or into the ignition electrodes or electrode cage during operation.</p> <p>The electrode for ionization measurement is live while the fuel valves are open. However, a current limiter in the unit prevents any danger from arising.</p>
--	---

In general, this warning can be enabled or disabled in the menu of the device depending on whether this function is desired or not.

Under which circumstances the warning will be displayed depends on the settings you have chosen and various operation modes, providing that the warning LED has been activated in the menu:

Selected input	Warning while the safety timer is counting down	Warning while the device is in receiving mode or respectively ready to fire mode
Firing key	Yes	Yes, continuously
12-24V	Yes	Ja, continuously
DMX512	Yes	As soon as the safety channel is received with values between 60% and 80%.
Serial data cable (RS485 of the PFC)	No	As soon as the controller's command 'Firing mode armed' has been received until the command 'Firing mode disarmed' is being received.
Wireless (PFC or PFS)	No	As soon as the controller's command 'Firing mode armed' has been received until the command 'Firing mode disarmed' is being received.

TIP

When using a Galaxis controller for the correct function of the warning LED it is required that the firing mode is disarmed when the G-Flame is put into operation. Furthermore the G-Flames must be within radio range of the transmitter. On the edge of the coverage area or if radio interferences are disturbing the transmission it can absolutely happen that some commands are received and others are not. This applies also for the display of the warning. Due to that you should take care for good range and operating conditions so that the warning signal will be displayed reliably.

13 The LED indicators

This section describes the LED indicators which can be found right above the display:

13.1.1 The LED 'Operation' (blue)

This blue LED displays the operating mode. While the safety timer is counting down or the device is in the menu this LED is continuously on. In this case no flame effect can be initiated.

If the device is in receiving mode or ready to fire mode this LED is flashing. Only if this is the case a flame effect can be generated.

13.1.2 The LED 'Flame' (yellow)

This yellow LED goes on as soon as the electromagnetic fuel valves are opened.

If the Advanced wireless module is installed you can program step delays and so called atomic effects in the menu of the device or remotely via the wireless link.

If an atomic effect has been initiated the LED goes on as soon as the electromagnetic valves are opening and not when the delayed ignition happens.

When a step delay has been programmed and the firing command for this is being received by the device this LED starts to flash until the electromagnetic valves are opened. During a flame effect this LED is continuously on.

13.1.3 The LED 'Charging' (green)

This green LED is on as soon as the charging voltage is present and the battery is being charged. With this indicator you can check if the charger is functioning properly. If the battery was completely discharged it takes up to 30h for a full charge.

13.1.4 The LED 'Low Battery' (red)

This LED starts to flash in red color in the receiving mode or respectively ready to fire mode if the internal battery has been discharged below 30% and together with the flashes you will hear an acoustic warning signal if the loudspeaker has been enabled. In such a case you should connect the charger soon in order to charge the battery completely again. A full charge takes up to 30 h.

13.1.5 Functional check of the LEDs

Immediately after powering up the device a function test of the LEDs is performed. First the LED 'Operation' goes on for one second, followed by the LED 'Flame' and the LED 'Low Battery' while the start messages are being displayed.

The LED 'Charging' can only be supplied by the charging unit and due to that this LED stays inactive during the LED test sequence.

14 The menu

Certain menu functions of the G-Flame are depending on the selected control method. In this chapter we will first explain the standard menu with all standard menu items. The control variants 'Firing key' and '12-24V' will be described. Later the menu items of the other control methods will be explained.

14.1 Standard menu items

14.1.1 The menu item 'Language'

```
Sprache/Language
English
```

Here you can select the language of the menu and all display texts of the receiving mode or respectively the ready to fire mode.

14.1.2 The menu item 'Accumulator capacity'

You see e.g. this result in the display:

```
Accumulator
Capacity: 95%
```

In this example the remaining charging level is 95%. If the value decreases below 30% the charging reserve is being touched. If the battery is being discharged to 0% damages due to deep discharging are possible.

TIP

The display of the accumulator capacity is related to an ambient temperature of 20°C. A fully charged battery could also lead to a reading of e.g. 80% if the temperature is very low.

TIP

The result of this menu item can also be displayed at the controller PFC Advanced by using the function 'Remote data request', provided that the Advanced wireless module has been installed.

No result regarding the accumulator capacity can be acquired as long as the battery is being charged. In this case you will see the following information in the display:

```
The accumulator
is being charged
```

The results may be higher directly after charging. We recommend to wait an operation time of approx. 10 minutes to gain realistic results.

14.1.3 The menu item 'Accumulator power'

By activating 'Mode' you will proceed in the menu and see e.g. this text in the display:

```
Accumulator
Power: 99%
```

To get information regarding the battery power it is discharged with a very high current for a short period of time. The device is analyzing the voltage drop and recovery during this process and is then able to compare the results in relation to an optimum value. The measured parameter is the capability of delivering high current that can decrease during the chemical aging process of the battery. A fully charged battery should have a result of at least 60%.

TIP

The result of this menu item can also be displayed at the controller PFC Advanced by using the function 'Remote data request', provided that the Advanced wireless module has been installed.

14.1.4 The menu item 'Input'

In this menu item you can select one of the following control methods by activating 'Up' and 'Down':

Input: Firing
Key (Contact)

Direct control input by using a firing key or any other potential-free electrical contact.

Input: 12-24V

Direct control input for voltages.

Input: DMX512

DMX512; later you will be able to switch on the power supply for wireless DMX pens if you want to use this technology.

Input: Cable
(RS485 of PFC)

This option is only being displayed if the Advanced wireless module has been installed. Use this selection if you want to use the G-Flame in conjunction with a PFC Advanced and if serial data cables should be used for the communication. 'RS485' is the cable interface of the controller PFC Advanced. RS485 is the name of the technical standard of the interface being used here for the serial data communication between devices on data cables.

Input: Wireless
(PFC or PFS)

This option is only being displayed if the Advanced wireless module has been installed. Use this selection if you want to use the G-Flame in conjunction with a PFC Advanced, PFS Profi or a PFS Profi or the wireless USB modem PFM Advanced and if the wireless link should be used.

The result of this menu item can also be displayed at the controller PFC Advanced by using the function 'Remote data request', provided that the Advanced wireless module has been installed.

TIP

The feedback information during remote data requests and programming will always be sent on both data exchange carriers: by radio signal and on the cable. You may select which way you want to use for the feedback in the menu of the controller PFC.

For the explanations given hereafter we assume that either 'Firing Key' or '12-24V' has been selected as control method.

14.1.5 The menu item '45° Tilt Switch'

In this menu item you can determine if the flame effect should be terminated or if the fuel valves should remain closed if the G-Flame is tilted by more than 45°.

45° Tilt Switch:
On

The shutoff of the flame effect and the inhibition of the fuel valves if the tilt angle is too is enabled.

45° Tilt Switch:
Off

The status of the tilt switch will be ignored. Use this selection only if you want to operate the G-Flame with a tilt angle of more than 30°.

TIP

The tilt switch is a mechanical component. Strong vibrations or accelerations on the vertical axis may cause the tilt switch to respond even though that the device is standing upright. In these exceptional cases it can be meaningful to disable the tilt switch.

14.1.6 The menu item 'Flame monitoring'

Right next to the electrodes for the ignition of the flame another electrode has been installed which is used to measure the ionization of the flame. A flame is so to speak electrically conductive and this physical phenomenon is utilized by the electronic circuits of the G-Flame to detect if the flame is burning or not.

Flame
monitoring: On

Here the shutoff of the flame effect and of the fuel valves if the flame is not burning is enabled. If no flame is detected for more than one second the valves are closed automatically. The device is terminating the fuel supply for this firing command.

Flame
monitoring: Off

With this setting the results of the ionization measurement will be ignored.

TIP	With every new firing command another attempt will be made to ignite the flame and in this process the fuel valves will be opened for a maximum time of one second. If no flame can be ignited several times one after another you should disable the G-Flame for the reasons of safety either by using the emergency-off input or the hazard zones (Advanced wireless module required for this) to prevent that an unnecessary amount of unburned fuel is set free
------------	---

TIP	For the reasons of safety, you should generally enable the ionization measurement.
------------	--

<p>WARNING</p>  <p>2.3.2</p>	<p>Ignition failure</p> <p>The ejected gas stream does not ignite.</p> <ul style="list-style-type: none"> • Make sure that the minimum distance to persons required in commercial stage technology is maintained. • Minimize the stay in the danger zone. • Activate the flame monitoring system.
--	---

14.1.7 The menu item 'Acoustic Signals'

This menu item switches the acoustic signals of the device on or off. Beep tones etc. may be disturbing on theatre stages and in this case, it is meaningful to disable the sounds. Please note that there will be no acoustic signals at all if the sounds are turned off, even no warning signal if the battery needs recharging.

Acoustic
Signals: On

In this example the acoustic signals are enabled.

14.1.8 The menu item 'LCD Backlight'

This text for example is being displayed:

```
LCD Backlight :
auto & dimmed
```

The display backlight is turned on automatically as soon as the menu is called up or messages are being displayed. The display is illuminated slightly (dimmed) in all other cases. That enables you to read the display content in darkness without any further action required. The power consumption for this slight permanent illumination is negligible.

```
LCD Backlight :
auto & off
```

If you choose this setting the display backlight is completely turned off as soon as the device is not in the menu or if there is no message. This is preferable in some applications where the slight illumination of the display could be disturbing.

```
LCD Backlight :
always off
```

With this setting the display backlight is off all the time.

14.1.9 The menu item 'Warning LED'

In this menu item the following options can be selected:

```
Warning LED (!) :
On
```

The warning LED is switched on. When a warning signal will be given is explained in detail in the chapter 'The warning LED 'Attention armed' '.

```
Warning LED (!) :
Off
```

No warning signal will occur.

14.1.10 The menu item 'Battery measurement'

This additional feature is used for measuring the capacity.

The menu items accumulator capacity and accumulator power measure very quickly the actual charging level of the battery and the ability of the battery to deliver current. Basically, the battery voltage is being monitored for these measurements.

The amount of energy an accumulator can store is decreasing during the aging process. Many factors affect this deterioration such as the chemical aging process itself, the storage temperature, the number and deepness of discharge cycles.

Possibly the amount of energy the battery can store is much less after some years of ageing than it was initially. However, the battery will show high results as a percentage value after charging due to the fact that the off-load voltage is still high. In principle the percentage value refers always to the amount of energy which can be stored in the particular battery. The loss in capacity becomes noticeable only in a shorter operation time. The test results in the menu are falling faster accordingly.

To measure the accumulator capacity precisely it was necessary to send the device to the manufacturer for an accurate battery test procedure. With this useful function you can do this battery measurement with precise capacity metering yourself at the device. In the end the result is being displayed in mAh and as a percentage value by which you can easily decide if the battery needs to be replaced.

Including a full charge before and after the discharge cycle this procedure requires approx. three days.

Proceed this way to perform an accumulator capacity measurement:

Position the device evenly and connect the supplied charging unit. Establish a reliable power supply for the charging unit. Power failures should be avoided. In this case the test sequence will be cancelled to prevent deep discharges and the risk of damaged batteries which could occur in this situation. The ambient room temperature should be between 15 and 25 °C.

Invoke this menu item. You will see the following on the screen:

Start Batt. Yes
Measur. ? No

You can start the test sequence by activating 'Up'. You will skip this menu item with 'Mode' or 'Down'.

Please connect charging unit!

After starting the test sequence, the device checks if the charging unit is supplying charging current. You will see this message if the charger is not yet connected or if the charger has no mains supply. Establish proper charging now and remain the charger connected permanently.

1. Charging
1800 Min. remain

After starting the sequence this is being displayed. Before the discharge cycle (measurement) it is essential that the battery is fully charged otherwise the result would be incorrect. The device will charge the battery for 1,800 minutes (= 30 h) to ensure that even a completely discharged battery will be fully charged. The remaining time is being displayed continuously. You can skip the initial charging process by activating 'Mode' in order to save time. You should not do this if you are not completely sure that the device's battery has been charged continuously before for at least 30 h.

2. Discharging
13.1V 0 mAh

Subsequently the battery is being discharged and the amount of energy which is drawn is being measured.

After some time e.g.:

2. Discharging
12.4V 617 mAh

The current battery voltage and the capacity in mAh which has been drawn so far is being displayed for your information. This process lasts until the final discharge voltage is reached. If necessary, you can cancel the test by activating 'Mode' for a longer time. After cancelling make sure that the device is charged for a sufficient period of time before using it again.

After the discharging process a final charging process is following. E.g. these messages are being displayed alternately:

3. Charging
1727 Min. remain

Here you are informed about the remaining duration of the charging process. Again 30 h are required in total.

3. Charging
12.0V 6.513 mAh

In the lower line next to the current battery voltage the capacity in mAh which has been discharged during the measurement is being displayed.

You may also terminate the final charging process by activating 'Mode'. In this case you are responsible that the battery is being charged sufficiently afterwards. You will directly enter the receiving mode or respectively ready to fire mode.

If the sequence is not cancelled you will see e.g. this being displayed:

4. Finished
93% 6.513 mAh

The test result as a percentage value and the capacity in mAh which has been measured during discharging is being displayed in the bottom line. In addition an acoustic signal is audible which should inform you that the test is finished.

The percentage value should help you to interpret the test result correctly. 100% represent 7,000 mAh, this is the nominal capacity of the battery being used. Results over 100% are possible, too.

If the battery reaches more than 75% (more than 5,250 mAh) it is fairly good. If the result is ranging between 60 and 75% (between 4,200 und 5,250 mAh) the battery should be replaced soon. If the result is less than 60% the battery should be replaced urgently.

TIP

You as the operator can easily replace the battery yourselves.

Normally operation is still possible if the battery shows a bad result. A low capacity leads to a shorter operation time. In some cases also the maximum current that can be drawn from the battery can be reduced if the inner resistance of the battery has risen. Before using the device again you should also observe the parameter 'Accumulator Power' in the menu.

It is making sense to test the accumulator regularly. We recommend to do this at least twice a year but not more than four times a year. Due to the fact that the measurement is a full discharge cycle batteries that have become inactive will be refreshed. Several measurements one after another can definitely lead to an enhancement in battery performance and increased capacity.

If the test cycle is conducted too often the negative effect of an accelerated ageing is rather likely to occur.

There are two possibilities why a measurement has been cancelled:

Terminated: no
charging voltage

The charging voltage was interrupted for an unacceptably long time. To avoid damages the device cancelled the test. Maybe the charger has been disconnected or a power failure of the mains supply occurred. Establish the power supply and start the test sequence again. If your mains supply is unreliable it is recommended to use an UPS (= Uninterruptible Power Supply).

Terminated by
user

Somebody cancelled the test before a result was gained.

If a power failure of the charging voltage occurs during charging or discharging you will hear an acoustic signal in the first instance. When the interruption lasts for too long the device terminates the measurement to avoid damages. If no UPS (= Uninterruptible Power Supply) is being used you should check once in a while if everything is OK.

14.2 Menu items if DMX512 has been selected as an input

The following menu items are only being displayed if DMX has been selected as the input.

14.2.1 The menu item 'Flame Channel'

Flame Channel:
001♦

With 'Up' and 'Down' you can select a DMX channel ranging from 1 to 512 which should be used to control the flame effect. Confirm your selecting with 'Mode'.

The functionality is described in detail in the chapters 'The DMX512 input' and 'Control via DMX512'.

14.2.2 The menu item 'Safety Channel'

In addition to the flame channel a so-called safety channel must be programmed.

Safety Channel:
013♦ 60-80% = ✓

With 'Up' and 'Down' you can select a DMX channel ranging from 1 to 512 which should be used as the safety channel. Confirm your selection with 'Mode'. If you have for example 12 G-Flames in use it is meaningful to use the DMX channel 1 to 12 as control channels and the next DMX channel, in this case 13, as a safety channel on all devices.

A value between 60% and 80% (decimal values between 153 and 204) has to be received on the safety channel in order to enable flame effects.

The functionality is described in detail in the chapters 'The DMX512 input' and 'Control via DMX512'.

It is not permitted to use the same channel number for the flame and the safety channel. In this case the following will be displayed on the LCD:

Identical DMX
Channels!

This screen is being displayed for some seconds. After that the device jumps back to the menu item 'Flame Channel' so that different channels can be programmed.

You can only exit the menu if different channels have been selected.

14.2.3 The menu item 'Power Supply for Wi-DMX'

Frequently the autarkic operation is an important aspect in the practical usage of the G-Flame. Besides the Advanced wireless module which enables the wireless communication between the device and a Galaxis controller you may also use wireless DMX solutions, either as an additional option or exclusively.

Here, it is a major disadvantage if DMX receivers as a desktop device offer wireless communication but require first of all a wall power supply and mains power and secondly a cable connection to the G-Flame in order to feed in the DMX signal.

Due to that various manufacturers offer wireless DMX Pens, which can simply directly be plugged into the jacks for the DMX signal. The G-Flame has been equipped with the necessary hardware to supply power to these DMX Pens so that no additional source of power is required and autarkic operation becomes possible also this way.

With this menu item you can switch the power supply for these DMX Pens either on or off:

Power Supply for
Wi-DMX: Off

There is no voltage output with this setting.

Power Supply for
Wi-DMX: On

With this setting +5VDC on Pin4 and ground (0V) on Pin5 will be applied.

All DMX Pens can be used that need a supply voltage of 5V and not more than 700 mA.

TIP

The DMX Pens offered on the market have a rather high-power consumption compared to the electronic circuits of the G-Flame. Therefore, if this technology is being used the operation time is reduced from usually 60 h to approx. 10 h.

TIP

For best reception during wireless DMX operation you should not directly plug in the DMX Pens and respectively this is maybe even not possible in certain circumstances. Instead use a short DMX cable to operate the DMX pens in some distance. You can for example use some gaffa tape to fix the DMX Pens on the side of the housing so that the antenna is pointing upwards and reception is not impaired.

14.3 Menu items if the Advanced wireless module has been installed and 'Cable (RS485 of PFC)' or 'Wireless (PFC or PFS)' has been selected as control method

The following menu items appear only if the Advanced wireless module has been installed and 'Cable (RS485 of PFC)' or 'Wireless (PFC or PFS)' has been selected as control method.

14.3.1 The menu item 'RF Channel' (i.e. frequency selection)

This menu item enables the user to determine which radio channel (RF = Radio Frequency) is being used by the device. You can choose from 70 different frequencies (channel 0 to 69). The particular frequency is being displayed in the bottom line.

```
RF Channel: 69◆
= 434.775 MHz
```

If you are changing the RF channel you will have to program all other devices to the new RF channel to ensure proper radio communication.

TIP

It is not allowed to operate two or more systems which are only differing in the programmed RF channel in relative proximity (within radio range). In this case there is no safety in regard to unintended firings. To safely operate two or more systems in relative proximity in addition either different system IDs need to be assigned by the manufacturer or different system IDs need to be assigned by the user.

14.3.2 The menu item 'Interfering Signal'

This is the next menu item. You may see this being displayed:

```
Interfering
Signal:      5%
```

The device is measuring and displaying the signal strength on the used radio frequency permanently as long as this menu item is present.

Normally this function is used to find out the cause of a radio interference. Values below 15% are uncritical. If the radio channel is busy you can select another frequency. Please see the section 'RF Channel' in this manual for further information.

TIP

The result of this menu item can also be displayed at the controller PFC Advanced by using the function 'Remote data request'.

TIP

You can use this menu item for a range test, too. Activate the firing mode at your controller PFS Profi, PFS Pocket or PFC Advanced. The device is now measuring the signal strength of your controller. By changing the location of the G-Flame you can try to find out which installation is best. You should definitely switch off the firing mode before you quit the menu and always make sure that there is no unintended activation of the firing button at the controller during the range test.

14.3.3 The menu item 'Last Range Test Result'

You will enter this menu item with another activation of 'Mode'. This function is mainly intended for users who are operating the transmitter PFS Profi or PFS Pocket. The new controller PFC Advanced is now offering the comfort of requesting the result of the range test remotely as well as the PFM Advanced USB Modem.

This function comes in handy if you do the set-up of the system without a helping person. After starting a range test at the transmitter, the G-Flames are displaying the results for approx. 10 seconds. Within this short period of time you cannot check the results of many different devices all over the place. This function enables you to ease this task.

Proceed this way:

- Switch on the G-Flames and start a range test at the controller.
- Go to each device, step through the menu and read the result which is being displayed under 'Last range test result'. This value has been displayed during the test.
- You can do another test if you like after reading all results.

```
Last Range Test
Result:        ?%
```

This means that there is no result stored in the memory of the device. There are several possibilities: Maybe no range test was made so far or the device was not within the radio coverage area. Another reason could be that the result has just been cleared by invoking this menu item before.

```
Last Range Test
Result:        65%
```

In this example the signal level was 65%. Values below 30% are critical.

TIP

The result is being cleared after stepping through the menu to ensure that the same result is not being displayed again after the next range test although the G-Flame is possibly out of reach. If you are using this function it is essential to read all the old results before starting a new test to make sure that they are all being cleared!

14.3.4 The menu item 'Device ID number'

```
Dev. ID No. for
bidir. Comm.:  -
```

This is the next menu item in the menu. A device ID number ranging from 1 to 999 can be programmed here. The device ID number is used as an identification address during bi-directional remote access. If no device ID number has been programmed the G-Flame cannot be accessed from the controller PFC during remote data requests and programming. Normally the devices are programmed with ID numbers in consecutive order. It is not allowed to program the same ID number to more than one device.

14.3.5 The menu item 'Determine Hazard Zone'

```
Determine
Hazard Zone:  A✓
```

Here you can change the hazard zone of the G-Flame. The default setting zone is hazard zone A. The check symbol indicated that the hazard zone is active, i.e. the G-Flame processes firing commands and generates flames according to the cue programming.

```
Determine
Hazard Zone:  E✓
```

You may use up to 16 different hazard zone. These hazard zones are represented by the letters A to P. In this example the G-Flame has been assigned to the hazard zone E.

TIP

If you change the hazard zone in the menu the status is 'active' by default. Thus, firing commands will be processed and flame effects will be generated. If a specific hazard zone has been deactivated and you select another zone in the menu for the time being and then select the previous hazard zone this zone will be activated by doing so. The 16 hazard zones can be deactivated and also activated again according to your requirements in the manual and automatic firing mode of the controller PFC Advanced. For this please read the user manual of the controller PFC Advanced.

The hazard zone which is currently assigned to the device and its status is being displayed in the receiving mode. You see e.g. this being displayed on the G-Flame's LCD:

```
Firing Mode: Off
Hazard Zone:  G✓
```

In this example the hazard zone 'G' has been assigned to device. The hazard zone is active.

```
Firing Mode: Off
Hazard Zone:  Gx
```

The symbol 'X' right next to the hazard zone indicates that this hazard zone has been deactivated. Flame effects are suppressed until this hazard zone is activated again.

TIP

The status of the device's hazard zone is always active after switching the G-Flame on. Due to that firing commands will be allowed. We assume that all hazard zones should be active after powering all devices up so that only those hazard zones need to be deactivated which bear a risk in terms of safety.

TIP

When you enable or disable hazard zones at the controller the G-Flame displays the current status of the hazard zone right after receiving the command if this hazard zone has been assigned to this device. The display backlight is activated also to show that the device has received the command. This is useful if you want to test if the G-Flames respond to the hazard zone commands.

14.3.6 The menu item 'Terminal Programming'

According to the similarities between the G-Flame and the Galaxis Advanced receivers we also speak of a Terminal programming when operating the G-Flame. Terminal programming means that several firing cues are programmed to a specific output and different durations can be defined in doing so. In principle the G-Flame is an Advanced receiver with a single output. Consequently user-defined flame effects like various flame balls or flame columns can be generated again and again during a show.

TIP

In this section the programming of the Terminal function in the menu of the G-Flame is explained. Please note in this context that all these parameters can also be programmed remotely - which is very convenient - by using either the controller PFC Advanced or any PC or notebook computer via the wireless USB modem PFM Advanced.

14.3.6.1 Overview regarding the parameters of the Terminal programming

The following parameters can be programmed at the G-Flame for each firing cue (1...999):

Parameter name	Range of values	Resolution
Duration	0.1 ... 25.0 seconds	0.1 seconds
Step Delay	0.00 ... 99.99 seconds	0.01 seconds = 10 ms
Atomic Effect	0.0 ... 0.7 seconds	0.1 seconds

The parameter 'Duration' determines how long the fuel valves will be opened. Shorter values for the duration create flame balls, longer values create flame columns.

With the parameter 'Step Delay' time delays are programmed. By doing so the most extreme step sequences can be achieved. The high resolution of only 10 ms enables the user to create extremely fast step chases and dynamic changes in the stepping speed. The functionality is identical with the receiver PFE Advanced 10/100 outputs and in the user manual of this device the application of the step function is described in detail.

The parameter 'Atomic Effect' is a special effect. It is a delay of the electrical ignition which takes place after the fuel valves have been opened. The longer this delay is the more unburned fuel is accumulating above the burning chamber. In the moment of the ignition the amount of fuel in the air is much higher and a nice flame ball similar to an atomic explosion with swirling turbulences is being created. In this context you should be informed that the maximum delay for the atomic effect is 0.7 seconds. Furthermore, the programmed duration must be at least 0.1 seconds longer than the atomic effect delay. The firmware of the G-Flame and of the PFC Advanced prohibits that improper values are programmed for these parameters.

TIP

It can be also appealing to use the atomic effect in conjunction with flame columns which last several seconds to enhance the impression of the whole effect.

14.3.6.2 The selection menu of the Terminal programming

By activating 'Up' and 'Down' you may choose between the following options:

```
Terminalprogr.:
Keep up & Exit
```

```
Terminalprogr.:
Edit
```

```
Terminalprogr.:
Delete
```

14.3.6.3 The menu item 'Terminal programming: Keep up & Exit'

```
Terminalprogr.:
Keep up & Exit
```

If you activate 'Mode' here you quit the menu of the terminal function without having changed any parameter. Use this selection also if you want to exit the menu of the terminal function after having made another selection before, for example after having entered a programming.

14.3.6.4 The menu item 'Terminal programming: Edit'

```
Terminalprogr.:
Edit
```

If you activate 'Mode' here you will enter the menu for editing the terminal function.

```
C:  1♦  T:  ---s
D:  0.00s  A: ---
```

'C' stands for 'Cue', which is the firing channel.
'T' is the parameter duration ('T' for lat. tempus).
'D' stands for 'Delay', which is the step delay.
'A' stands for 'Atomic effect'.

After invoking this edit menu firing cue 1 is pre-selected. The double-headed arrow indicates which parameter can be currently changed with 'Up' and 'Down'. After deletion of the memory no durations are programmed at all. In this case '---' is being displayed for the duration and the atomic effect. '0.00' is being displayed as a step delay.

If '---' is being displayed for the duration, this means that for this firing cue no flame will be generated by this device.

Programming example:

- Firing cue 4 should generate a short flame ball with a duration of 0.3 seconds
- With cue 7 a flame column with a duration of 4.2 seconds should appear.
- Cue 12 should generate an atomic effect with a duration of 0.9 seconds and an atomic effect delay of 0.7 seconds.
- Cue 17 should trigger a short flame ball with a duration of 0.5 seconds and an atomic effect delay of 0.4 seconds. This flame effect is part of a step sequence and due to that a step delay of 1.47 seconds should be counted down before the effect will be generated.

```
C:  4♦  T:  ---s
D:  0.00s  A: ---
```

As long as the double-headed arrow is being displayed next to the cue number you can select the cue, in this example cue 4, which should be assigned with a flame effect by activating 'Up' and 'Down'.

```
C:  4♦  T:  ---s
D:  0.00s  A: ---
```

With each short activation of 'Mode' the double-headed arrow jumps to the next parameter. You have to activate 'Mode' once for a short time to determine the firing duration.

```
C:  4   T:  ---s♦
D:  0.00s  A: ---
```

Now you can enter the duration for this firing cue by activating 'Up' and 'Down'.

```
C:  4   T:  0.3s♦
D:  0.00s  A: ---
```

According to the programming example 0.3 seconds have been entered.

```
C: 5♦ T: ---s
D: 0.00s A:---
```

Activate 'Mode' three times for a short period to skip the parameters atomic effect and step delay. Then you will have the opportunity to edit the programming of the next cue. If the double-headed arrow jumps to the cue number again the cue number will be incremented automatically.

```
C: 7♦ T: ---s
D: 0.00s A:---
```

Select cue number 7 by activating 'Up' two times for a short period.

```
C: 7 T: 4.2s♦
D: 0.00s A:---
```

Jump to the parameter duration by activating 'Mode' once for a short period and enter the value 4.2 seconds with 'Up' and 'Down'.

```
C: 12♦ T: ---s
D: 0.00s A:---
```

Skip the parameters atomic effect and step delay and select 12 as firing cue in order to proceed with the entries for this cue.

```
C: 12 T: 0.9s♦
D: 0.00s A:---
```

Enter the duration how long the valves will be opened, in this case 0.9 seconds.

```
C: 12 T: 0.9s
D: 0.00s A:0.6♦
```

Right after that you can enter the ignition delay (atomic effect) which is in this case 0.6 seconds. This parameter can be edited in the range of 0.0 to 0.7 seconds. The effect duration must be at least 0.1 seconds longer than the ignition delay.

```
C: 13♦ T: ---s
D: 0.00s A:---
```

Activate 'Mode' two times for a short period to reach the parameter firing cue. The device increments the cue number automatically so that cue 13 is being displayed.

```
C: 17♦ T: ---s
D: 0.00s A:---
```

Select cue number 17 with 'Up' and 'Down'. The you program, as already described above, an effect duration of 0.5 seconds and an atomic effect of 0.4 seconds. Rotate through the edit menu with 'Mode' until you reach the parameter step delay.

```
C: 17 T: 0.5s
D: 0.00s♦ A:0.4
```

Now enter the desired step delay by using 'Up' and 'Down'.

```
C: 17 T: 0.5s
D: 1.47s♦ A:0.4
```

As soon as you are finished with your entries activate 'Mode' for a longer time to exit the edit menu.

```
Terminalprogr.:
Nicht ändern
```

Right after doing so the device returns to the submenu of the Terminal programming. With another activation of 'Mode' for a short period you will exit this submenu and reach the main menu.

TIP

By activating the magnetic sensor fields 'Up' and 'Down' for a longer time you can change the current parameter rapidly.

TIP

If you are using the atomic effect, which is also a firing delay, in a music synchronized show you have to take these delays into consideration during the design of the show. In principle this parameter must be handled like the rising time of a display shell. The particular cues must be fired earlier according to the atomic delay so that the flame effect will be synchronized with the music.

TIP

The parameters flame duration, atomic effect and step delay can also be programmed remotely, which is very convenient, either with the controller PFC Advanced or the Galaxis PYROTEC Composer software in conjunction with the wireless USB modem 'PFM Advanced'. Furthermore, you can and perform remote data request.

14.3.6.5 The menu item 'Terminal programming: Delete'

```
Terminalprogr.:  
Delete
```

All possibly programmed durations (T), all atomic effects (A) and all step delays (D) in the memory of the G-Flame will be deleted with this function.

```
Are you      | Yes  
sure?       | No
```

After activating 'Mode' this safety request is being displayed and you can start the deletion process with 'Up'.

```
The memory has  
been deleted!
```

This message is being displayed after deleting the memory, which only takes a short moment. Subsequently the device return to the submenu of the terminal programming.

15 Receiving mode or respectively ready to fire mode

Right after switching on and after the safety timer has elapsed the device enters the receiving or respectively the ready to fire mode. Flame effects and bi-directional remote access functions are only possible in this operation mode. If wireless communications is being used we are speaking of receiving mode. Otherwise it is called ready to fire mode. Which information is being displayed in this mode is depending on the selected control method.

In the following chapter we will describe which messages are being displayed one after another. In general, first the selected control method is being displayed, followed by additional screens regarding the operation status and settings.

15.1 Displayed information during receiving mode or respectively ready to fire mode, that appears in all operation modes

15.1.1 Information which control method has been selected

Depending on the selected control variant one of the following screens is being displayed:

```
Input: Wireless
(PFC or PFS)
```

```
Input: Cable
(RS485 of PFC)
```

```
Input: Firing
Key (Contact)
```

```
Input: 12-24V
```

```
Input: DMX512
F:003-, S:012x
```

The programmed flame channel and safety channel is being displayed if DMX512 has been chosen as an input ('F' = Flame channel, 'S' = Safety channel).

In addition, the status of the safety channel or respectively of the DMX reception is being displayed. 'x' means that either no signal is being received or that the value of the safety channel is not between 60% and 80% (= generation of flame effects is not enabled).

'✓' after the safety channel indicated that a DMX signal is being received and that a value between 60% and 80% is being received for the safety channel (= device armed).

```
Input: DMX512
F:0030, S:012✓
```

This example shows the display content if the device is armed by the safety channel (noticeable by the '✓' after the safety channel) and if the flame channel has activated a flame effect (flame symbol next to the flame channel).

15.1.2 Tilt switch on/off and its status

```
Tilt Switch: On
Status: OK
```

In general, it is being displayed if the tilt switch has been enabled or not and the status of the tilt switch. The tilt switch is enabled in this example, i.e. the flame effect will be terminated if already in progress or flame effects will be disabled if the device is tilted by more than 45°. Status OK means that the G-Flame is not tilted by more than 45° and the generation of flame effects is enabled.

```
Tilt Switch: On
Status: >45°
```

Here the device is tilted by more than 45° and flame effects will be terminated if this condition is detected during a flame effect and the fuel valves will remain closed if the tilt angle is exceeded in the moment of triggering an effect.

```
Tilt Switch: Off
Status: >45°
```

The tilt switch has been turned off in the menu. The G-Flame will ignore a tilt angle of more than 45° and flames will be generated, no matter how much the device is being tilted.

15.1.3 Flame monitoring on/off

```
Flame
monitoring:  On
```

Here the flame monitoring system has been deactivated in the menu. The device is measuring the ionization of the flame immediately after the beginning of the ignition phase to determine if the flame is really burning and if it has been completely ignited. If no flame is being detected for more than one second the fuel valves will be closed.

```
Flame
monitoring:  Off
```

In this example the flame monitoring has been disabled in the menu of the device.

15.2 Display of special information and behavior of the device in the receiving mode or respectively ready to fire mode if 'Wireless (PFC or PFS)' or 'Cable (RS485 or PFC)' has been selected as control method

After the selected control method, the status of the tilt switch and the flame monitoring system will be displayed. Right after that the following screens will be visible:

15.2.1 Status information regarding firing mode and hazard zone

```
Firing Mode:  Off
Hazard Zone:  K✓
```

The status of the firing mode is being displayed (on or off). Please note in this context that the device is assuming that the firing mode is disarmed at the controller when being switched on. If the G-Flame is powered after the firing mode has been armed 'off' will be displayed nevertheless. Furthermore, this wrong usage leads to the detection of a radio interference because the G-Flame interprets the signal of the controller as an interference. In addition, the hazard zone the device has been assigned to plus if this zone is active or not is being displayed ('✓' = active, 'x' = inactive). The hazard zone is active by default after powering up the device and must be deactivated by a command from the controller if necessary.

If the status of one of these parameters is changing the device immediately jumps to this screen and in addition the display backlight is switched on, if it has been enabled in the menu.

TIP

Every time the firing mode is turned on or off the controller transmits this information to the receiver. If the status of the firing mode is being changed the G-Flame can only display the current status of the firing mode correctly if they are in the receiving mode and within radio coverage.

TIP

If the firing mode is being switched off all possibly opened electromagnetic fuel valves are closed (command 'Firing mode off'). In addition, all stepping sequences that are currently in progress are terminated, provided that the G-Flames are within radio range and that this information is being received

15.2.2 Display of the device ID number

```
Dev. ID No. for
bidir. Comm.: 15
```

Then the device ID number for bi-directional communication which has been assigned to this device is being displayed.

15.2.3 Display of messages

The following messages are possible if the Advanced wireless communication module is being used. If enabled in the menu the display backlight is switched on, too, so that it becomes apparent which device is displaying a message.

```
Transmitting
data...
```

A remote access is currently in progress. The device is transmitting data to the controller or the wireless USB modem.

```
Writing
data...
```

A remote access is currently in progress and data is written to the memory of the G-Flame.

```
Remaining Range:
          50%
```

A radio range test is currently in progress and the result is being displayed (no bi-directional remote access but a range test as it is can be conducted with the PFS Profi or PFS Pocket and as it has been also implemented in the PFC Advanced to provide downward compatibility to devices of the Profi series).

```
Fire
Channel:      999
```

This is being displayed when firing commands are being received. If a flame effect has been programmed for the firing cue the yellow 'Flame' LED goes on in addition or it starts to flash if a step sequence is in progress.

```
RF Channel:   69
= 434.775 MHz
```

The G-Flame received the command to change the radio frequency. The new radio channel and the frequency is being displayed.

15.2.4 Programming of the system ID

The G-Flame can be taught to different systems ID, just as it is possible with the Advanced receivers. This procedure is called 'Teach-In' and is used if systems are split into several ones or if devices are lent or rented out to other customers. After the return of the devices they can be e.g. taught to the original system ID again.

To teach-in a system ID 'Up' must be activated while the device is in receiving mode and then the command for the teach-in must be sent. Immediately after that the following confirmation message is being displayed:

```
Teach-In
successful
```

The device will automatically return to the receiving mode after this message.

15.2.5 The monitoring function Radio Interference

The G-Flames are monitoring their frequency permanently. An interference is present if an external carrier with a signal strength of more than 30% in respect to 100% maximum signal strength of the system is present for more than 45 seconds.

Radio
Interference!

This message is appearing if a radio interference has been detected. If the display backlight has been activated the display will be illuminated periodically, too. In this case it is advisable to check if the G-Flame has been installed close to a strong source of interference. Therefore, enter the menu item 'Interfering Signal' and check if there is a higher value all the time.

By stepping through the menu with the magnetic pen the warning 'Radio Interference' will be cleared. The device is always ready for use even if you do not clear this warning message.

TIP	If you switch on a G-Flame while the transmitter is in the firing mode the G-Flame will display the warning message 'Radio Interference' soon. The PFS Profi, PFS Pocket and the PFC Advanced are transmitting continuously (i.e. they are active carriers) if they are in the firing mode. If you change from normal mode to firing mode the controllers are telling the receivers that a continuous and intended transmission will follow. If a G-Flame has been switched on after this or was in the menu while this signal has been sent it will interpret the signal of the own transmitter as an interfering signal.
TIP	You can select another frequency in the menu of the device if the used radio channel is busy or if there is an interference. Of course, you have to select the same frequency also at the controller and all other receivers if additional devices are in use (only possible with Advanced series).
TIP	The frequency (i.e. radio channel) can also be changed remotely with the controller PFC Advanced or the wireless USB modem PFM Advanced
TIP	Using the controller PFC Advanced the warning 'Radio Interference' and the level of interference can even be checked remotely

16 Switching off

If possible, you should switch off the device only if it is currently not in the menu. You may switch it off anytime if it is in receiving mode or respectively ready to fire mode or if the safety timer is counting down. Otherwise changes of parameters in the concerned menu item will not be saved.

You should also not switch it off while a remote programming or a remote check is performed by the Advanced wireless module.

Press the main switch to switch off the device.

<p>CAUTION</p>  <p>2.4.5 2.5.1</p>	<p>Strong heating of the device during operation</p> <p>During operation, the following parts of the device can heat up considerably:</p> <ul style="list-style-type: none"> • the casing, in particular the parts forming the combustion chamber • the electrode cage • the ignition electrodes • the electrode for ionization measurement <p>Do not touch these parts until they have cooled down sufficiently and the unit is switched off.</p>
--	---

Alternatively, you can also power down the unit by using the emergency off input, i.e. by opening the electrical contact that is connected to this input. In principle the main switch and the emergency off switch are wired in series. Please note when powering down the device with the emergency off input that still there is a small power consumption. Due to that you should also switch off the device with the main switch if the device is not used for a longer time.

The usage of the emergency off input is very recommendable to power down the device with sufficient safety distance and then activate the main switch. Especially when using DMX512 we recommend this procedure because this control signal contains no safety measures.

17 Command 'Firing mode off'

If you operate the Advanced wireless module you can send the command 'Firing mode off'. This command is always being sent when the firing mode is disabled. If this command is being received opened electromagnetic fuel valves are closed, the electrical ignition is switched off and step sequences - if in progress - are terminated, provided that the device is within radio range.

18 Radio range

If the standard antenna is used under good conditions the range is 800 m and can be increased up to 2.000 m by using the antenna Superscan 70 or Superscan 71.

Higher radio range is available on request.

It is a general rule that the higher the antenna is positioned the better the reception will be. Please do not hesitate to ask our personnel for more information about the various possibilities of range improvement.

TIP	An antenna extension cable should be used for the Superscan 70 or Superscan 71 in order to mount the antenna separated to ensure that the generated flame cannot damage the antenna.
------------	--

TIP	Do not use the high gain antennas Superscan 70 and Superscan 71 together with the remote access functions because in this mode the device is also transmitting data and the radio approval would be voided.
------------	---

18.1 Radio Range Test

The remote access functions of the controller PFC Advanced make very convenient radio range tests possible because the signal strength of both devices (signal back and forth) are displayed at the controller.

If you want to read the test result at the G-Flame or if you work with the transmitter PFS Profi or PFS Pocket the radio range test can also be done the conventional way.

After starting the test procedure, the G-Flames will for example display the following text:

```
Remaining Range:
                50%
```

This result means that the distance to the transmitter can be approximately doubled until the signal will be too low. In general, you should try to achieve at least a signal level of 30%.

19 Remote access

If the device has been accessed remotely via the wireless link or the serial data cables one of the following text messages will be displayed depending whether data is being read from the device or data is being written to the memory of the G-Flame:

```
Transmitting
data...
```

The device is transmitting while the controller or the wireless USB modem is receiving data.

```
Writing
data...
```

The controller or the wireless USB modem is transmitting data which is written to the memory of the G-Flame.

If the radio channel is being changed by a remote command the new radio channel and the frequency in MHz is being displayed:

```
RF Channel: 69
= 434.775 MHz
```

20 Operation time

As soon as the device is in operation power is consumed from the internal battery. If this accumulator is totally charged and has the full capacity of 7,000 mAh 30% of energy will be left after an operation time as stated below. Continuous operation is possible if the device is being charged permanently.

The values have been calculated assuming that the Advanced wireless module is installed, which consumes energy in addition, and that the fuel valves are opened for a total time of three minutes during the application.

Operation mode	Maximum operation time
Control with firing key input	110 h
Control with voltage input	110 h
Wireless control	110 h
Control via serial data cables (RS485)	70 h
Control via DMX on cables	70 h
Control via DMX and supply of wireless DMX Pens with a current consumption of typically 0.65A @ 5VDC	10 h

TIP

Please be aware of the fact that the rechargeable battery is losing capacity over the life time. The achievable operation time depends on the actual capacity of the particular battery. You can determine the capacity of the batteries by starting the battery measurement function in the menu.

21 Installation of accessories

<p>DANGER</p>  <p>2.3.8</p>	<p>Use of non-original accessories or operation without specified components</p> <p>The safe operation of the device cannot be guaranteed, if non-original accessories and components are used. All specified parts must be used to operate the device (e.g. pressure reducer).</p> <ul style="list-style-type: none"> • Use only components and accessories approved by the manufacturer. • Use all components specified by the manufacturer.
---	---

21.1 Installation of the Advanced wireless module

The Advanced wireless module can be retrofitted by the user himself if the G-Flame has not been equipped with this optional feature when initially ordering the device.

21.1.1 Installation of the hardware

Open the side panel (cover lid) of the device.

Then remove the blind cover of the antenna socket on the upper side of the device by opening the two screws. Afterwards you can insert the BNC feed through socket and mount it with the same screws.

The wireless module will be mounted with two screws that have already been installed in the device. These screws have been secured with two self-locking nuts and you will find them on the side of the housing in the device near the connector which is intended to plug in the wireless module.

Open the two self-locking nuts and remove the screws.

Insert the wireless module in the 25pin connector (25pin S-Sub socket) which can be found on the front side of the printed circuit board which is installed in the device.

The wireless module comes with two inserted nuts which will lay exactly behind the holes in the housing once the module is completely inserted.

Mount the wireless module by using the screws which you removed before.

Then you have to connect the BNC feed trough socket with the BNC connector of the wireless module by using the short piece of antenna cable with a BNC connector on each end which has been supplied with the module.

Insert and close the cover lid and press it against the housing so that the latching mechanism is holding it in position.

Every time you want to control the device wirelessly the supplied antenna must be installed.

21.1.2 Software installation of the Advanced wireless module

After the wireless module (hardware) has been installed the software installation routine can be carried out. By doing so the microcontroller of the G-Flame is notified that the wireless module is now connected to the main board and the behavior of the firmware is changing accordingly.

Switch on the G-Flame while you activate the sensor fields 'Up' and 'Down' by using two magnetic pens until you see this being displayed:

Wireless Option:
Off

You may select between 'On' and 'Off' with 'Up' and 'Down'.

Wireless Option:
On

Select 'On' in order to install the module, then activate 'Mode'.

Right after that the following ticker will be displayed:

Call the Galaxis office and tell the token. You will receive the activation code. Continue with Mode.

If you now activate 'Mode' a random eight-digit sequence of numbers will be generated and displayed, the so called token. Tell us this token on the phone and will give you the corresponding activation code.

TIP

You may speed up the ticker by activating the 'Mode' sensor field and keeping it activated.

The sequence is as follows:

Token:
53582820

Example of a token being displayed. This screen is being displayed sufficiently long so that you can tell us the token on the phone.

Code?
◆

Then you see this request to enter the activation code which you will receive from Galaxis on the phone. With 'Up' and 'Down' you can change the digits. If you see the correct number being displayed activate 'Mode' to proceed. A '0' can be entered the easiest by activating 'Mode' without activating 'Up' or 'Down' before.

Code? OK
44232502◆

The activation code, which has also eight digits, has been accepted und the deep discharge counter has been reset to zero. No more warning message will be displayed any more until the next occurrence.

Code? X
5423250200◆

A wrong activation code has been entered and the code was not accepted. Switch off the G-Flame and repeat the procedure.

21.2 De-installation of the wireless module

TIP

Before you remove the wireless-module, it must be deactivated in the software of the device. Otherwise the device can no longer be operated because the attempt to initialize the wireless module is failing.

21.2.1 De-installation of the wireless module in the software

Switch on the G-Flame while you activate the sensor fields 'Up' and 'Down' by using two magnetic pens until you see this being displayed:

Wireless Option:
On

You may select between 'On' and 'Off' with 'Up' and 'Down'.

Wireless Option:
Off

Select 'Off' in order to de-install the module, then activate 'Mode'.

After this 'Attention!' is being displayed in the upper line of the screen and below you will be able to read the following ticker text:

Reinstallation is only possible with support on the phone during the Galaxis office hours!

Subsequently the following safety request will be displayed:

Are you sure?	Yes No	Activate 'Up' if you really want to de-install the wireless module now. Otherwise you can select 'Down' to exit the sequence.
------------------	-----------	---

Immediately after selecting either 'Yes' or 'No' the device enters the ready to fire mode.

21.2.2 De-installation of the hardware

You can remove the wireless module by following the steps described in the section 'Installation of the hardware' in reverse order.

21.3 Optional accessory: Power Upgrade

The Power Upgrade is an optional accessory. It consists of a gas cartridge holder with an additional quick-coupler which is used to connect the already existing cartridge holder. Furthermore, a housing extension is supplied in order to cover the additional cartridges.

The G-Flame Power Upgrade allows you to use not only two but four cartridges. By doing so a total flame height of approx. eight meters is achieved. The total flame duration remains the same as specified for two cartridges with XXL nozzle.

Attention: The following nozzles have to be used in conjunction with the Power Upgrade:

- a) If the ambient temperature is higher than +5°C only the nozzle for liquid gas must be used together with the Power Upgrade. Never use any other nozzle than this one in this case.**
- b) If the ambient temperature is +5°C or lower the XXL nozzle has to be used stringently instead of the nozzle for liquid gas because otherwise fallout will happen which will result in fire on the floor due to burning gas residue.**

The recommended safety distances are as follows: 12 meters upwards and 6.5 meters sideways if the device is standing vertically on even ground. General notes regarding safety distances can be found in the section 'Safety distances' in this manual.

22 Maintenance and service life

<p>WARNING</p>  <p>2.2.1 2.3.4 2.4.1</p>	<p>Flammable atmosphere in/on the device</p> <p>When connecting or closing the gas containers, a flammable atmosphere could occur in/on the unit due to loose connections or leaks of the fuel-carrying components. An ignition spark could cause combustion or deflagration in/on the unit.</p> <ul style="list-style-type: none"> • Perform the pressure test of the fuel-carrying components as required in this operating manual. • Make sure that the bottom of the device (open) is not blocked. • Large recess on the underside of the unit below the fuel-carrying components, so that any escaping gas can be drained. • Do not use the unit if leaks are detected.
--	---

At the latest with every third application, the user should spray the seals of the quick couplers and the can holder with silicone spray to ensure that they remain elastic and provide a durable leak tight seal.

If the flame burns long after the valves close, the Teflon seal of the nozzles may need to be replaced or the nozzle is not screwed in sufficiently tight.

The rechargeable batteries can be tested by the user himself (please refer to the chapter 'The menu item 'Battery measurement' in this manual).

This device must be subjected to a leak test once a year. This can be carried out by the manufacturer or a specialist company for gas installations or heating engineers with additional qualification.

The following test pressures should be used:

Intended operation with aerosol cartridges or operation with gas bottles with gaseous phase: 10 bar

Intended operation with gas bottles, liquid phase: 12 bar

The holding time for both test variants is 15 minutes.

However, maintenance by the manufacturer is highly recommended. We recommend this every 12 or 24 months, depending on how often the device is used. In tour operation or for more than 30 applications per year, we recommend maintenance every 12 months.

The following work will be carried out:

- Firmware update if newer software is available
- Inspection and, if necessary, replacement of seals and O-rings
- Lubrication of seals
- Leak test with highly sensitive manometer
- Individual testing of each magnetic valve on its own
- Inspection and, if necessary, tightening of screws
- Checking and, if necessary, repairing screw locking measures
- Visual inspection of the circuit board and all electrical connections for corrosion or other damages requiring repair
- Replacement of damaged or defective components
- Cleaning of the device if necessary
- Cleaning or replacing the micro filter
- Complete function test including communication test
- Check of the frequency deviation of the radio modules if installed
- Adjusting the ignition electrodes and the ionization measurement electrode

Regular maintenance ensures a long service life and provides the basis for reliable and safe operation. In general, it can be assumed that safe operation can no longer be guaranteed after five years without maintenance by the manufacturer or an authorized dealer.

All quick couplers (both sides), all gas hoses and all pressure reducers generally have a service life of only eight years. Have these parts replaced by the manufacturer before this period has expired.

After 50,000 switching cycles, the magnetic valves should be replaced by the manufacturer.

23 Cleaning

The device is very robust. Please take care that e.g. no burning or hot cinders from firework effects fall onto the device, because this may cause damage to the surfaces.

Ensure that the device is switched off before you clean it.

Use a piece of cloth that was moistened with water and at the most some dishwashing agent, for cleaning the device. Solvents, strong detergents and abrasives could damage the surfaces.

Keep all electrical contacts always clean.

Unburned carbon may accumulate at the ignition electrodes, the ionization measurement electrode and on the electrode cage. This is absolutely normal and does not impair the function of the device.

If a lot of unburned carbon has accumulated, we recommend to clean the ignition electrodes and the electrode cage by using a soft brush. Pay attention not to bend the electrodes. In case that the soot cannot be removed this way moisten the brush with brake cleaner. The ionization measurement electrode can be cleaned by using a piece of cloth.

The gap between the tips of the ignition electrodes should approx. 3 mm.

All fuel-carrying components, such as the quick couplers, gas cartridge receptacles and the fittings on the hoses and pressure reducers, are not allowed to become dirty. Always keep them absolutely clean to prevent leakages.

24 Micro filter

This device is equipped with a micro filter. This largely prevents dust particles or foreign particles from getting into the fuel valves and leading to malfunctions and leakages.

Devices produced until September 2017 have a screwable fine filter. Before each use of the units, check that the O-ring is functional and that the filter is hand-tight and leak-proof.

Devices produced since October 2017 have a permanently installed filter. This does not have to be checked for tightness.

After frequent use over a longer period of time, the filter may have to be cleaned. This is usually recognizable by a lower flame height. In this case, please send the unit to the manufacturer to have the filter cleaned or replaced. Under certain circumstances it is possible that the manufacturer is instructing you how to clean the filter yourself.

If devices are sent in for maintenance it can happen that it is necessary that the screwable filter is exchanged against the permanently installed filter.

25 Warranty

The warranty period is 24 months.

If there is any defect during in this period please pack the device properly and send it to the manufacturer with carriage paid to have it repaired free of charge. Please do not forget to attach a description of the symptoms, which have occurred.

Warranty is excluded if the device was damaged due to wrong usage or excessive stress.

Unauthorized repairs and the use of non-original parts will void all warranty, guarantee and product liability claims with immediate effect.

26 Damages caused by misuse, maloperation, malfunction

The devices have been designed to generate flame effects. Discuss all other applications with the manufacturer before usage. In the case that one of the events stated above has happened we are only liable if the causation was within our range of influence. The devices have been developed, manufactured and tested to the best of our knowledge and belief.

Especially the user's work must comply with the safety instructions and the instructions given in this manual at all times.

A long test period and our practical experience proved that the devices operate very safe and reliable even if used in difficult conditions.

27 Technical data

27.1 General data

Radio parameters EU version (if Advanced radio module is installed)	<p>Frequency Band: 433.05 - 434.79 MHz Maximum radio-frequency power transmitted: ≤ 10 mW Channel Spacing: 25 kHz Number of radio channels: 70 (433.050 - 434.775 MHz) Modulation: FM narrow band Frequency Shift: +/- 3 kHz Duty Cycle: $< 10\%$ Radio equipment class according to 2014/53/EU (RED): 1 Radio equipment type: non-specific short-range device, transmitter and receiver (Transceiver) Receiver Category according to ETSI EN 300 220 V3.1.1: demanded by the application: 3 (lowest performance level) fulfilled by the device: 1.5 (second-best performance level) Receiver Principle: Double superheterodyne Receiver Sensitivity: -119 dBm @ 12 dB SINAD Wave Length: 70 cm Standard antenna included in delivery: Center Frequency: 434 MHz Radiation Pattern: omnidirectional Radiator Length: $\lambda/4$, not coiled Antenna Gain: 0.00 dBd, 2.15 dBi</p>
Radio parameters US version (if Advanced radio module is installed)	<p>Frequency Range: 458 - 462.5 MHz License: FCC Part 90, FCC-ID: V9X-LMD400R Maximum radio-frequency power transmitted: ≤ 10 mW Channel Spacing: 12.5 kHz Number of radio channels: 360 (458.0000 - 462.5000 MHz) Modulation: FM narrow band Frequency Shift: +/- 3 kHz Receiver Principle: Double superheterodyne Receiver Sensitivity: -119 dBm @ 12 dB SINAD Wave Length: 65 cm Standard antenna included in delivery: Center Frequency: 460 MHz Radiation Pattern: omnidirectional Radiator Length: $\lambda/4$, not coiled Antenna Gain: 0.00 dBd, 2.15 dBi</p>
Protocol parameters (if Advanced radio module is installed)	<p>half-duplex, PCM with Manchester coding, Checksum: 40 Bit CRC, data rate approx. 2,500 bps</p>
Temperature range, excluding fuels	<p>Transport und storage: -30 to +70°C Operation: -20 to +65°C The maximum temperature difference between devices must not exceed 60 K in order to enable unimpaired radio communication. Optimal storage temperature for longest battery life: +10 to +20°C</p>
Humidity	10 - 90% rH, no condensation inside the device
Allowable altitudes above sea level	<p>Storage and transport: -500 to 12,500 m Operation: -500 to 4,000 m</p>
Ignition	Electrical arc
Number of electromagnetic valves	2, connected in series
Functional principle of the flame monitoring system	Ionization measurement

Dimensions (LxWxH) and weight, each without antenna:

300 x 300 x 350 mm; 10.50 kg

Power supply and charging concept:

2 x 12 V, 7 Ah, sealed lead acid type rechargeable battery, PYROTEC charging device

Supplied accessories, included in delivery of the device:

1 Charging unit
 1 Magnetic pen
 1 User manual

The following parts are included in the gas cartridge option:

- cartridge holder (T-piece with quick-coupler, two non-return valves and two shut-off valves)
- special nozzle for cartridge operation, size XXL

The following parts are included in the gas bottle option:

- gas hose with a length of 5 m and a quick-coupler
- pressure regulator 1-4 bar
- special nozzle for gas bottle operation, gasiform phase

When buying a G-Flame either the gas cartridge or the gas bottle option is included in the purchase price.

The following parts are included if an Advanced wireless module is ordered:

1 standard antenna
 1 BNC feedthrough socket to be installed in the housing of the G-Flame
 1 antenna cable with two BNC connectors to establish the connection between the BNC antenna feedthrough and the Advanced wireless module

The following parts are included in the optional Power Upgrade:

1 cartridge holder with two quick-couplers, to be used between G-Flame and standard cartridge holder
 1 housing extension to cover all four cartridges
 The particular nozzles must be ordered separately if not at hand already.

Charging unit:

Mains voltage	100-240 VAC, 50-60 Hz
Power consumption	typ. 4.5 Watts
Charging time	Full charge within 30 h, no danger of overcharging, automatic trickle charge
Dimensions	L-W-H 80-74-29 mm
Weight	0.07 kg

27.2 Usage in rainy conditions

The device can also be used even in heavy rainfall. The housing protects the electronic circuits against the immersion of rain water, also if the rain hits the device sideways.

If rain water accumulates in the burning chamber it will be able to drain off through a drilling and a hose. Ensure that this drilling and the hose is not blocked by dirt or foreign particles.

It is prohibited to submerge the device into water or to operate it in any way that water enters the device from the bottom side.

As soon as the high voltage ignition is switched on a very hot electrical arc is being generated and the fuel can be ignited without any problems even in heavy rainfall.

Ensure that all wetness or moisture can dry off completely after each usage in the rain before you stow the devices in cartons, flight cases or similar.

28 Accessories

Below is a list of original accessories that can be obtained from the manufacturer or authorized distributors at any time. The device may only be operated with these original accessories. Otherwise, all claims arising from warranty, guarantee and product liability will become void with immediate effect.

Item No.:	Description:
1496	Aerosol cartridges for G-Flame
1341	Antenna extension cable 1m
1342	Antenna extension cable 2m
1345	Antenna extension cable 5m
1343	BNC-BNC adaptor
10162	Back plate for G-Flame
1498	Pressure regulator for gasiform phase. Operation with liquid phase strictly prohibited. Risk of accident!
1488	Nozzle for operation with gas cartridges size S
1489	Nozzle for operation with gas cartridges size M
1490	Nozzle for operation with gas cartridges size L
1491	Nozzle for operation with gas cartridges size XL
1492	Nozzle for operation with gas cartridges size XXL
1493	Nozzle for operation with gas bottles, gasiform phase
1494	Nozzle for operation with gas bottles, liquid phase
1206	Ext. firing key with XLR cable, 1 Output
15003	Flame Bar, straight, length 2m
15007	Flame Bar, octagon, diameter 48cm
1916	G-Flame Power Upgrade
1485	Gas cartridges option for G-Flame
1484	Gas bottle option for G-Flame, incl. 5m gas hose with quick couplers, pressure reducer for gasiform phase, operation with liquid phase strictly prohibited: Risk of accident! special nozzle for gas bottles
1917	Gas hose for G-Flame 10m
1918	Gas hose for G-Flame 15m
1301	Charging unit Profi series
1311	Magnetic pen
1302	Multi charging unit for up to 10 Profi devices
15001	Emergency Off Button
15000	Emergency Off Splitter 16-way
1499	Emergency Off Splitter 8-way
1320	Standard antenna
1322	Superscan 71, high gain antenna. Only approved for being used in receiving mode!
15020	LPG hose for liquefied gas, proof pressure 75 bar, 1m
15004	LPG hose for liquefied gas, proof pressure 75 bar, 5m
10216	LPG hose for liquefied gas, proof pressure 75 bar, 10m
1811	LPG hose extension for liquefied gas, 1m
1812	LPG hose extension for liquefied gas, 5m
1813	LPG hose extension for liquefied gas, 10m
1803	Gas hose adaptor for USA
1807	Extension for cartridge holder

29 CE marking of the EU version

The EU version of this device is marked with the CE logo:



30 Address of the manufacturer and contact details for requesting an EU declaration of conformity

Galaxis Showtechnik GmbH
Lohgerberstr. 2
84524 Neuötting
Germany

Tel.: +49 / 8671 / 73411
Fax: +49 / 8671 / 73513

Homepage: www.galaxis-showtechnik.de
E-Mail: info@galaxis-showtechnik.de

Please use these contact details if you want to request an EU declaration of conformity.